



POWERING INNOVATION THAT DRIVES HUMAN ADVANCEMENT

© 2025 ANSYS, Inc. or its affiliated companies
Unauthorized use, distribution, or duplication is prohibited.

Getting Started with HFSS™: Cable Modeling



ANSYS, Inc.
Southpointe
2600 Ansys Drive
Canonsburg, PA 15317
ansysinfo@ansys.com
<https://www.ansys.com>
(T) 724-746-3304
(F) 724-514-9494

Release 2025 R1
January 2025

ANSYS, Inc. and ANSYS
Europe, Ltd. are UL registered
ISO 9001:2015 companies.

Copyright and Trademark Information

© 1986-2025 ANSYS, Inc. Unauthorized use, distribution or duplication is prohibited.

ANSYS, Ansys Workbench, AUTODYN, CFX, FLUENT and any and all ANSYS, Inc. brand, product, service and feature names, logos and slogans are registered trademarks or trademarks of ANSYS, Inc. or its subsidiaries located in the United States or other countries. ICM CFD is a trademark used by ANSYS, Inc. under license. All other brand, product, service and feature names or trademarks are the property of their respective owners. FLEXIm and FLEXnet are trademarks of Flexera Software LLC.

Disclaimer Notice

THIS ANSYS SOFTWARE PRODUCT AND PROGRAM DOCUMENTATION INCLUDE TRADE SECRETS AND ARE CONFIDENTIAL AND PROPRIETARY PRODUCTS OF ANSYS, INC., ITS SUBSIDIARIES, OR LICENSORS. The software products and documentation are furnished by ANSYS, Inc., its subsidiaries, or affiliates under a software license agreement that contains provisions concerning non-disclosure, copying, length and nature of use, compliance with exporting laws, warranties, disclaimers, limitations of liability, and remedies, and other provisions. The software products and documentation may be used, disclosed, transferred, or copied only in accordance with the terms and conditions of that software license agreement.

ANSYS, Inc. and ANSYS Europe, Ltd. are UL registered ISO 9001: 2015 companies.

U.S. Government Rights

For U.S. Government users, except as specifically granted by the ANSYS, Inc. software license agreement, the use, duplication, or disclosure by the United States Government is subject to restrictions stated in the ANSYS, Inc. software license agreement and FAR 12.212 (for non-DOD licenses).

Third-Party Software

See the legal information in the product help files for the complete Legal Notice for Ansys proprietary software and third-party software. If you are unable to access the Legal Notice, please contact ANSYS, Inc.

Conventions Used in this Guide

Please take a moment to review how instructions and other useful information are presented in this documentation.

- Procedures are presented as numbered lists. A single bullet indicates that the procedure has only one step.
- Bold type is used for the following:
 - Keyboard entries that should be typed in their entirety exactly as shown. For example, “**copy file1**” means you must type the word **copy**, then type a space, and then type **file1**.
 - On-screen prompts and messages, names of options and text boxes, and menu commands. Menu commands are often separated by greater than signs (>). For example, “click **HFSS > Excitations > Assign > Wave Port.**”
 - Labeled keys on the computer keyboard. For example, “Press **Enter**” means to press the key labeled **Enter**.
- Italic type is used for the following:
 - Emphasis.
 - The titles of publications.
 - Keyboard entries when a name or a variable must be typed in place of the words in italics. For example, “**copy filename**” means you must type the word **copy**, then type a space, and then type the name of the file.
- The plus sign (+) is used between keyboard keys to indicate that you should press the keys at the same time. For example, “Press Shift+F1” means to press the **Shift** key and, while holding it down, press the **F1** key also. You should always depress the modifier key or keys first (for example, Shift, Ctrl, Alt, or Ctrl+Shift), continue to hold it/them down, and then press the last key in the instruction.

Accessing Commands: *Ribbons*, *menu bars*, and *shortcut menus* are three methods that can be used to see what commands are available in the application.

- The *Ribbon* occupies the rectangular area at the top of the application window and contains multiple tabs. Each tab has relevant commands that are organized, grouped, and labeled. An example of a typical user interaction is as follows:

"Click **Draw > Line**"

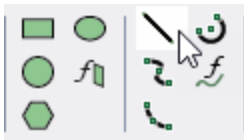

This instruction means that you should click the **Line** command on the **Draw** ribbon tab. An image of the command icon, or a partial view of the ribbon, is often included with the instruction.

- The *menu bar* (located above the ribbon) is a group of the main commands of an application arranged by category such File, Edit, View, Project, etc. An example of a typical user interaction is as follows:

"On the **File** menu, click the **Open Examples** command" means you can click the **File** menu and then click **Open Examples** to launch the dialog box.

- Another alternative is to use the *shortcut menu* that appears when you click the right-mouse button. An example of a typical user interaction is as follows:

"Right-click and select **Assign Excitation> Wave Port**" means when you click the right-mouse button with an object face selected, you can execute the excitation commands from the shortcut menu (and the corresponding sub-menus).

Getting Help: Ansys Technical Support

For information about Ansys Technical Support, go to the Ansys corporate Support website, <http://www.ansys.com/Support>. You can also contact your Ansys account manager in order to obtain this information.

All Ansys software files are ASCII text and can be sent conveniently by e-mail. When reporting difficulties, it is extremely helpful to include very specific information about what steps were taken or what stages the simulation reached, including software files as applicable. This allows more rapid and effective debugging.

Help Menu

To access help from the Help menu, click **Help** and select from the menu:

- **[product name] Help** - opens the contents of the help. This help includes the help for the product and its *Getting Started Guides*.
- **[product name] Scripting Help** - opens the contents of the *Scripting Guide*.
- **[product name] Getting Started Guides** - opens a topic that contains links to Getting Started Guides in the help system.

Context-Sensitive Help

To access help from the user interface, press **F1**. The help specific to the active product (design type) opens.

You can press **F1** while the cursor is pointing at a menu command or while a particular dialog box or dialog box tab is open. In this case, the help page associated with the command or open dialog box is displayed automatically.

Table of Contents

Table of Contents	Contents-1
1 - Introduction	1-1
2 - Set Options	2-1
3 - Create the Model	3-1
Insert HFSS Design	3-1
Enable Legacy View Orientations	3-3
Draw Polyline	3-5
Draw First Air Object and Assign Radiation Boundary	3-6
Create Cable 3D Component	3-9
Create Cable Harness	3-12
Draw Second Air Object	3-16
4 - Set Up Analysis and Solve	4-1
Adjust Initial Mesh Settings	4-1
Assign Mesh Operation	4-2
Add Solution Setup	4-3
Add Frequency Sweep and Solve	4-4
5 - Evaluate Results	5-1
Overlay Mesh Plot	5-1
Create Emission Test Report	5-2
Plot Radiation Pattern	5-5
Overlay and Animate E-Field	5-8
6 - Optionally, Restore Current View Orientations	6-1

1 - Introduction

You can now complete the entire cable modeling workflow within a single HFSS design. Cables are defined as 3D components. Required 2D Extractor and Circuit simulations are set up and run automatically in the background as part of the HFSS solution process. No manual setup, linking, or transfer of data is required on the analyst's part.

The 3D component definitions include conductor size, insulation thickness, arrangement of straight and twisted pair conductors, number of twists per unit length (for twisted pairs), materials, optional total angle of twist of the cable along its length, jacket type (braided shield, insulation, or none), and termination impedances and sources. The bundle of conductors is associated with a polyline in the Modeler window, and cylindrical geometry is automatically created to represent the wire harness. The diameter of the harness and arrangement of conductors is automatically determined by the program based on the number, size, and type of conductors.

Whether conductors are straight or in twisted pairs, a straight wire definition is required. For a twisted pair, the straight wire definition dictates the wire name, materials, conductor diameter, and insulation thickness. The twisted pair definition references the straight wire name and adds the twisted pair name, and number of twists per unit length or lay length (that is, the distance for a complete 360-degree twist). A harness can include multiple straight and twisted pairs of varying sizes and materials.

The model in this guide is a straight cable, 100 millimeters in length, consisting of a single twisted pair of copper conductors with PVC insulation, a PVC jacket, and no shield. The following image is a view of the completed model with the E-Fields overlaid on a small air object closely encompassing the cable. A larger air object, where a radiation boundary is assigned, is shown as a wire-frame:

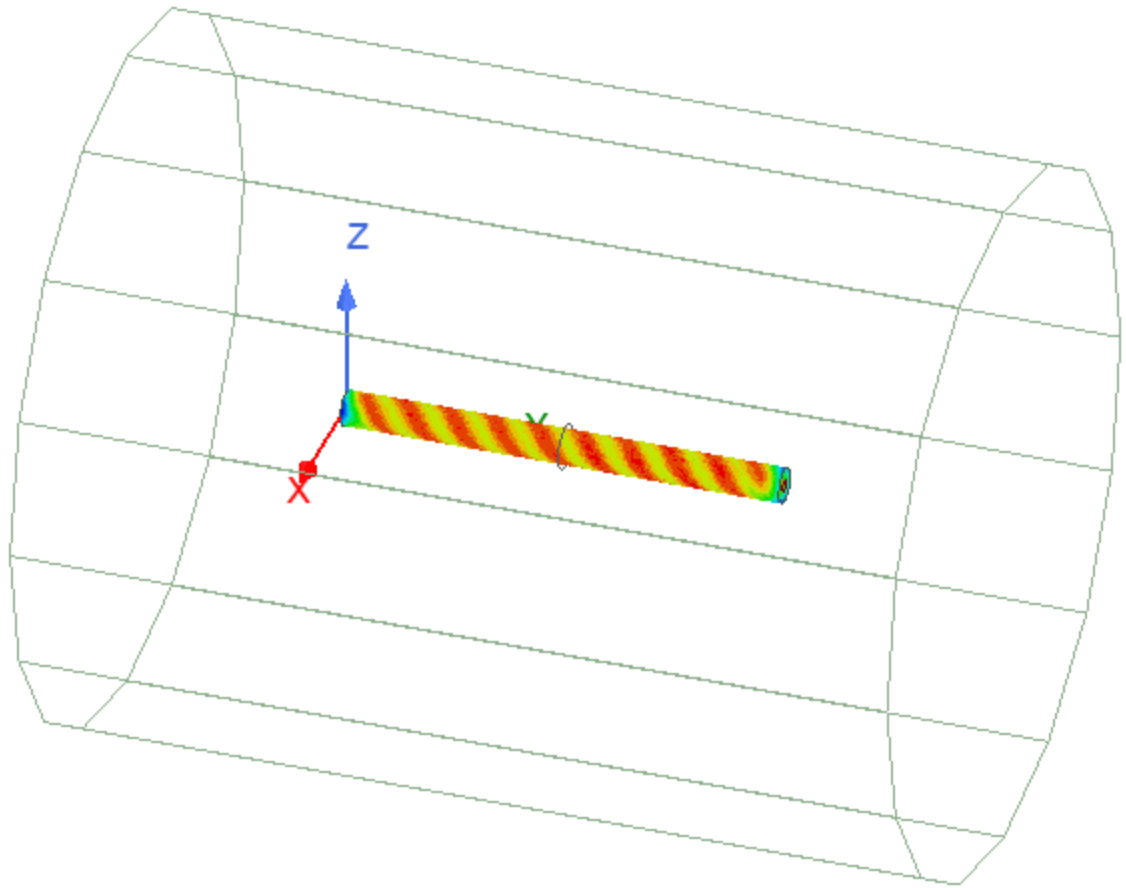

In this getting started guide, you will complete the following steps:

- Set options
- Start a new project and insert an HFSS design
- Enable legacy view orientations
- Draw a line to represent the path of the cable
- Draw an air object and assign a radiation boundary
- Create a 3D component to represent the cable
- Create the cable harness
- Draw a second air object (for plotting near fields)
- Adjust the initial mesh settings
- Assign a mesh operation to the smaller air object
- Add a solution setup and frequency sweep
- Solve the design
- Create an emission test report

- Create a polar plot of the radiation pattern
- Overlay E-field results near the cable
- Optionally, restore current view orientations

2 - Set Options

HFSS Cable Modeling Beta Option:

Before inserting an HFSS design and beginning to create the model, ensure that the HFSS Cable Modeling Beta Option is enabled, as follows:

1. If it is not already running, launch the Ansys Electronics Desktop application.
2. Use one of the following two methods of accessing the *Options* dialog box:
 - On the **Desktop** ribbon tab, click  **General Options**
 - From the menu bar, click **Tools > Options > General Options**
3. Ensure that **HFSS > Desktop Configuration** is selected in the tree at the left side of the dialog box:
4. Click **Beta Options**.

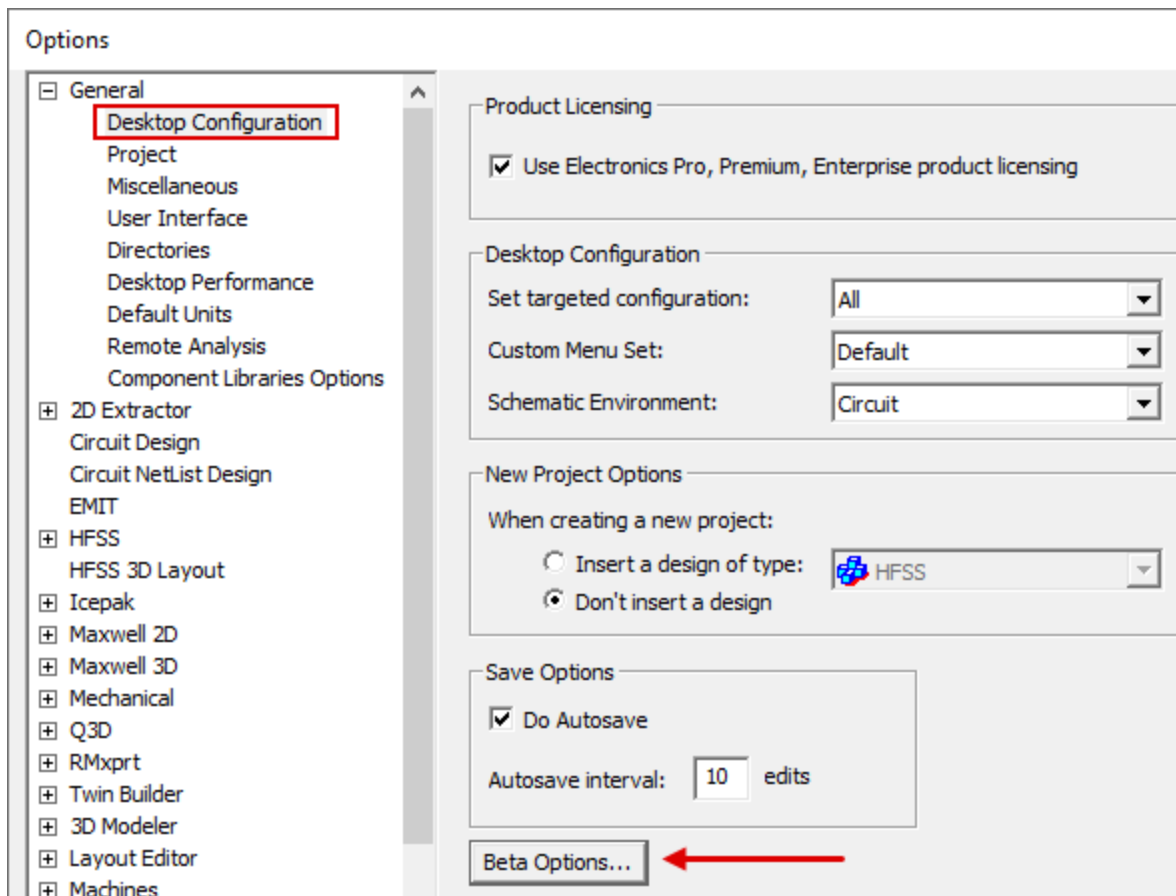

Then, in the dialog box that appears, do the following:

- a. Ensure that **HFSS Cable Modeling** is selected.

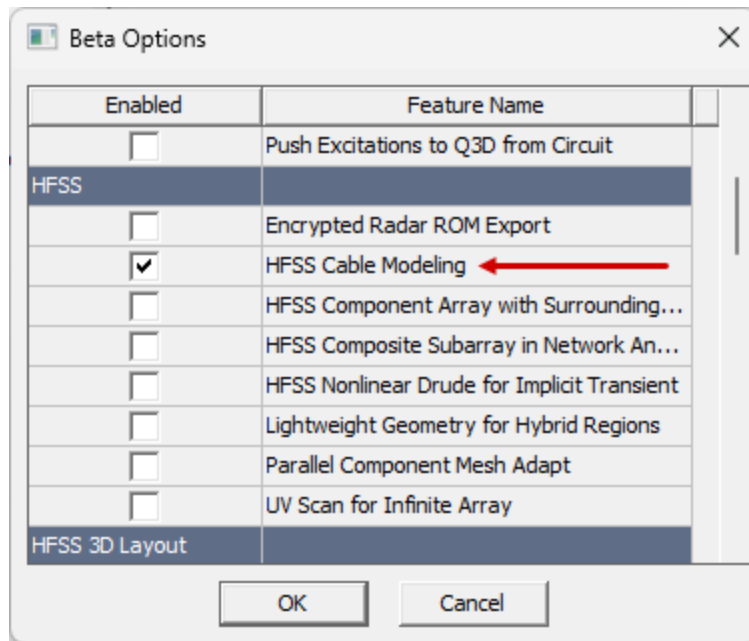

- b. Click **OK** to close the *Beta Options* dialog box.

Verify Drawing Options:

Next, ensure that the option to open a *Properties* dialog box automatically when a primitive object is drawn is not selected, as follows:

5. In the tree at the left side of the dialog box, expand the **3D Modeler** branch and select **Drawing**.
6. Ensure that the **Edit properties of new primitives** option is **cleared** (*not* selected).

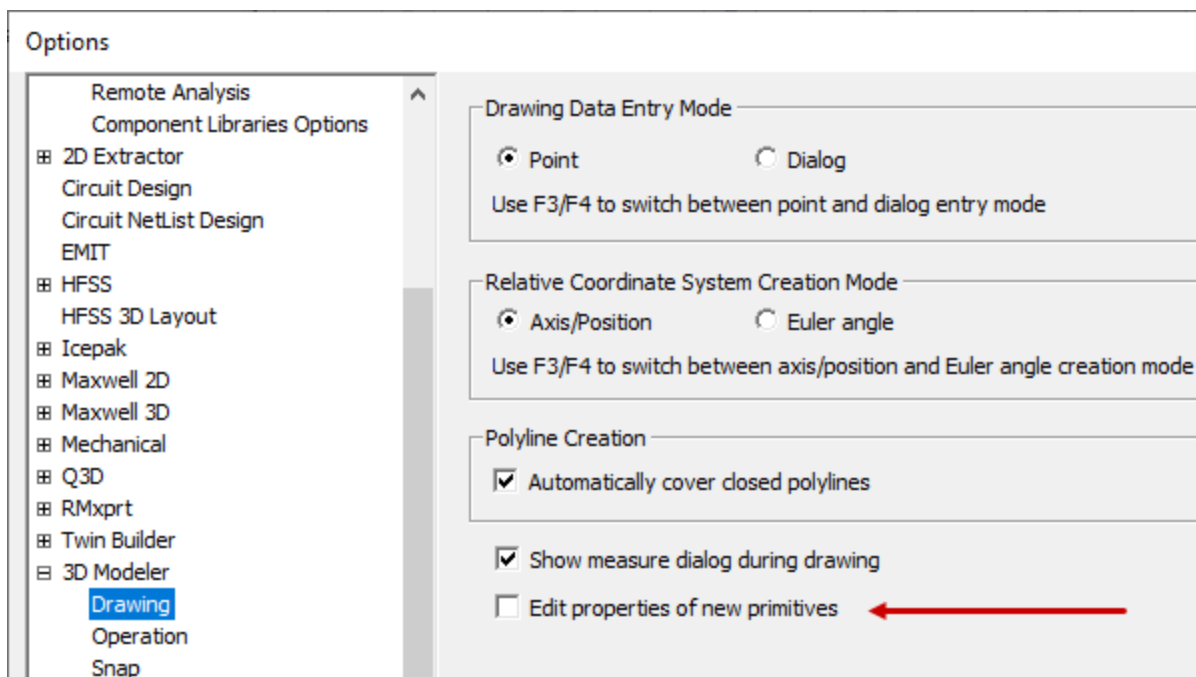

7. Click **OK** to close the *Options* dialog box.

3 - Create the Model

In this section you will complete the following steps:

- Insert an HFSS design into an empty project
- Enable legacy view orientations
- Draw a line to represent the path of the cable
- Draw an air object and assign a radiation boundary
- Create a 3D component to represent the cable
- Create the cable harness
- Draw a second air object (for plotting fields)

Insert HFSS Design

With Ansys Electronics Desktop already running and an empty project added, do the following to insert an HFSS design, specify the default drawing units, and save the project with the desired name:

1. Use one of the following two methods to add an HFSS design to the project:

- On the **Desktop** ribbon tab, click  **HFSS**. (You do not have to access the drop-down menu because inserting an HFSS design is the default action.)
- Using the menu bar, click **Project > Insert HFSS Design**.

By default, *HFSSDesign1 (Terminal Network)* appears beneath the project name at the top of the Project Manager. The default solution type (Terminal Network) is the appropriate choice for this exercise.

2. Optionally, if you have previously saved a default solution type other than *Terminal Network*, do the following:
 - a. Using the menu bar, click **HFSS > Solution Type**.
 - b. Select the options shown in the following image:

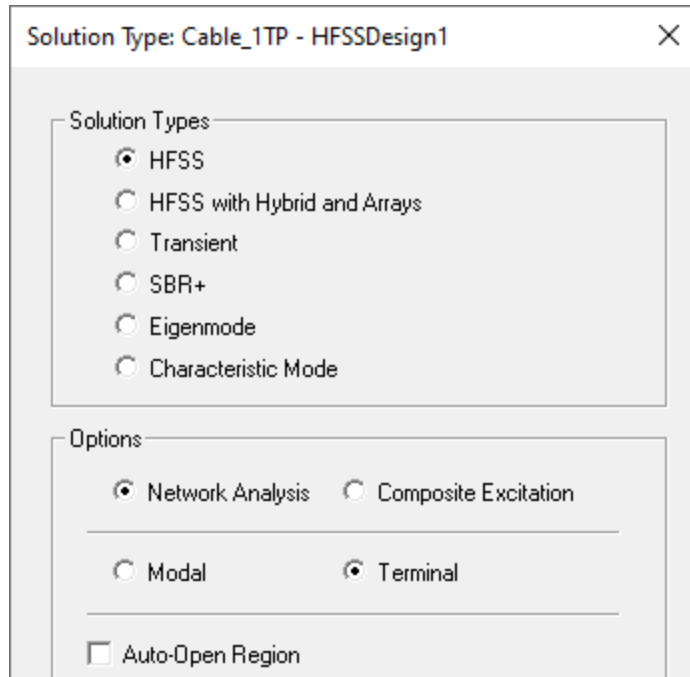

- c. Click **OK** to close the *Solution Type* dialog box.
3. On the **Draw** ribbon tab, click **Units** to access the *Set Model Units and Max Extent* dialog box. Then:
 - a. From the **Select units** drop-down menu, choose **mm** if it is not already selected.
 - b. Click **OK**.

You will specify all coordinates and dimensions for this exercise in millimeters.

- a. In the *Save As* dialog box, navigate to the folder where you want to save the project.
 - b. For the **File name**, type **Cable_1TP**, since the cable will contain a single twisted pair.
 - c. Click **Save**.
4. At the top of the Project Manager, right-click the project name and choose **Save As** from the shortcut menu. Then:
 - a. In the *Save As* dialog box, navigate to the folder where you want to save the project.
 - b. For the **File name**, type **Cable_1TP**, since the cable will contain a single twisted pair.
 - c. Click **Save**.
5. In the Project Manager, if the **HFSSDesign1 (Terminal Network)** branch is not expanded, click the plus sign (+) to expand it.

The Project Manager should look like the following image:

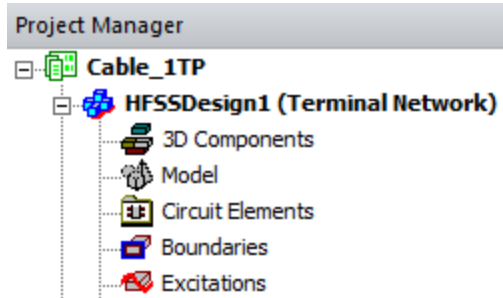

Enable Legacy View Orientations

This getting started guide was created based on standard view orientations that were in effect for version 2023 R2 and earlier of the Ansys Electronics Desktop application. For consistency between your experience and the views and instructions contained in this guide, select the *Enable Legacy View Orientation* option in the 3D UI Options dialog box, as follows:

1. From the menu bar, click **View > Options**.

The *3D UI Options* dialog box appears.

2. Select **Enable Legacy View Orientation**:

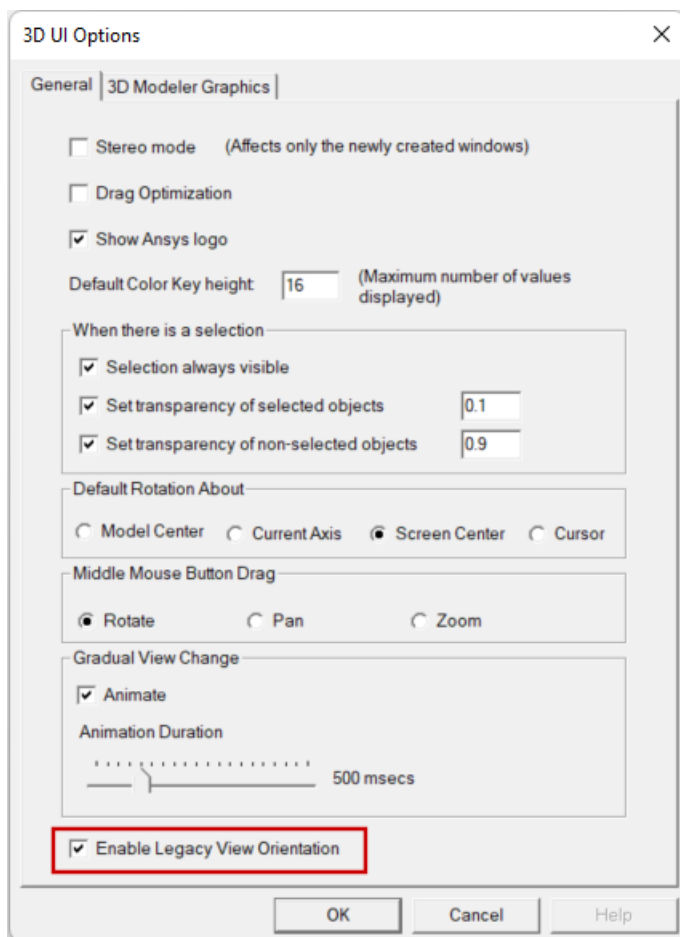

3. Click **OK**.

Changing the view orientation option does not change the model viewpoint that was in effect at the time.

4. On the **Draw** ribbon tab, click  **Orient** to change to the *Trimetric* view, which is the default legacy view orientation.

You do not have to select *Trimetric* from the *Orient* drop-down menu. The default view appears when you click *Orient*.

Although this option can only be accessed once a design is added to a project, it is a global option. Your choice is retained for all future program sessions, projects, and design types that use the 3D Modeler or that produce 3D plots of results.

At the end of this guide, you will be prompted to clear the *Enable Legacy View Orientation* option, if you prefer to use the view orientation scheme implemented for 2024 R1 and newer versions going forward.

For a comparison of the legacy and current view orientations, search for "View Options: 3D UI Options" in the HFSS help. Additionally, views associated with **Alt + double-click** zones have

been redefined. The current orientations are shown in the help topic, "*Changing the Model View with Alt+Double-Click Areas.*"

Draw Polyline

Draw a straight line, 100mm long, starting at the global origin, and running along the +Y axis:

1. Start the *Line* command using one of the following two methods:
 - On the **Draw** ribbon tab, click  **Line**
 - Using the menu bar, click **Draw > Line**
2. Click on the global origin to start the line.
3. Specify the endpoint of the line using the X, Y, and Z text boxes at the bottom of the screen, as follows. Be careful not to move the mouse while entering the coordinates, which would switch you back to the graphical input mode:
 - a. Press **Tab** to place the cursor in the **X** text box and type **0**.
 - b. **Tab** into the **Y** text box and type **100**.
 - c. **Tab** into the **Z** text box and type **0**.
 - d. Press **Enter** to complete the segment.
4. Right-click in the *Modeler* window and choose **Done** from the shortcut menu to finish the *Line* command.

Polyline1 appears under *Lines* in the History Tree.

5. On the **Draw** ribbon tab, click  **Grid** to toggle off the display of the drawing grid.

This step is necessary to prevent the grid from obscuring the visibility of the polyline just drawn.

6. On the **Draw** ribbon tab, click  **Fit All** and click in the *Modeler* window background to clear any selection.

The default *Trimetric* view of the model should look like the following image:



Draw First Air Object and Assign Radiation Boundary

In order to produce an emission report from the solved analysis, a radiation boundary must exist around the model. Far field results are extrapolated from the radiation boundary.

You could automatically generate a box-shaped region for this purpose. However, since the cable will be a cylindrical object, a cylindrical air region will place the radiation boundary at a consistent radial distance from the cable. Additionally, you will draw a segmented cylinder, approximating the outside diameter using sixteen flat faces. The segmented cylinder will mesh cleanly and with fewer elements than required to represent a curved face.

A typical padding distance between the model and the radiation boundary of the enclosing air region is one-fourth of the wavelength at the adaptive solution frequency. For this analysis, the adaptive frequency is 1 GHz, with a corresponding wavelength (λ) of approximately 300 mm. The outside radius of the cable is 1.3 mm, and the radius of the first air region 80 mm. Because the cylinder is segmented, the actual distance between the cable jacket and the radiation boundary varies from about 77.2 to 78.7 mm. The minimum padding distance (77.2 mm) is therefore slightly more than $\lambda/4$ (75 mm). We will use a reduced padding of 50 mm in the axial direction, equal to half of the cable length.

Draw the segmented cylinder using the *dialog* input mode, as follows:

1. Start the *Cylinder* command using one of the following two methods:
 - On the **Draw** ribbon tab, click  **Cylinder**
 - Using the menu bar, click **Draw > Cylinder**
2. Press **F4** to switch to the *dialog* input mode, if the *CreateCylinder* dialog box is not already visible. Then:
 - a. Specify the following settings under the **Command** tab of the *CreateCylinder* dialog box:

- *Center Position: 0, -50, 0*
- *Axis: Y*
- *Radius: 80*
- *Length: 200*
- *Number of Segments: 16*

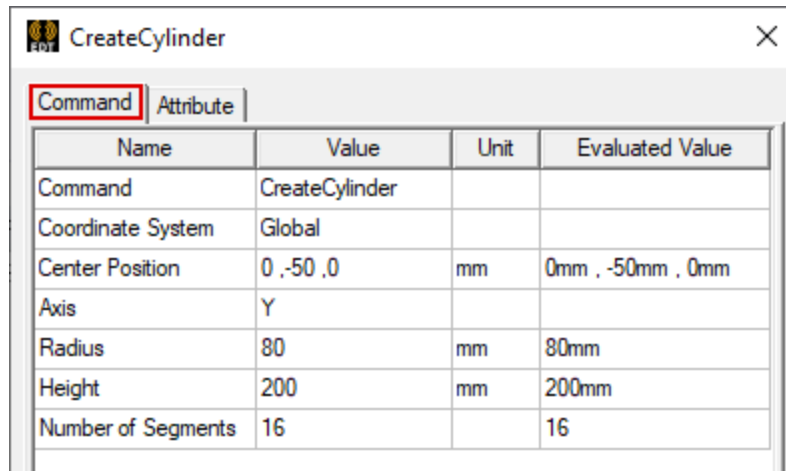

- b. Specify the following settings under the **Attribute** tab of the *CreateCylinder* dialog box:
- *Name: Cylinder_OR*
(where *OR* stands for *Open Region*)
 - *Material: air*
(Choose **Edit** from the **Material** drop-down menu to access the *Select Definition* dialog box, choose **air** from the *Materials SysLibrary*, and click **OK**.)
 - *Display Wireframe* check box: **selected**

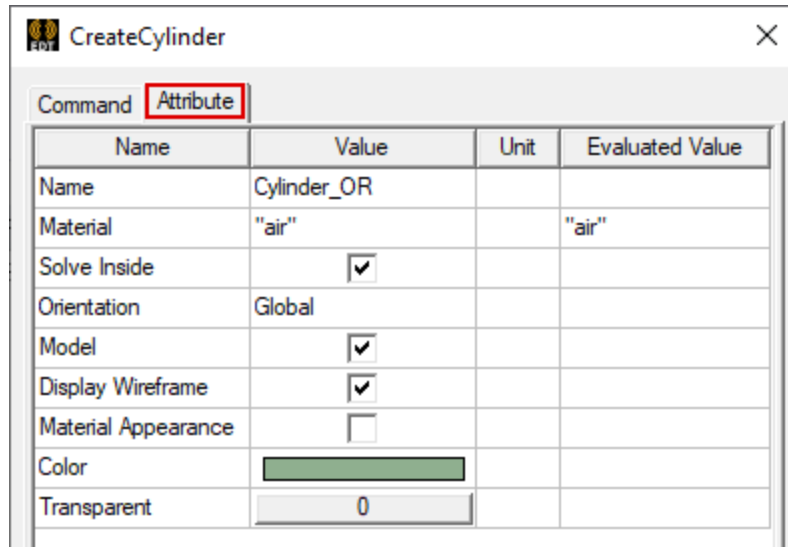

3. On the **Draw** ribbon tab, click  **Fit All**.
4. In **Object** selection mode, click the segmented cylinder just drawn (*Cylinder_OR*) to select it:

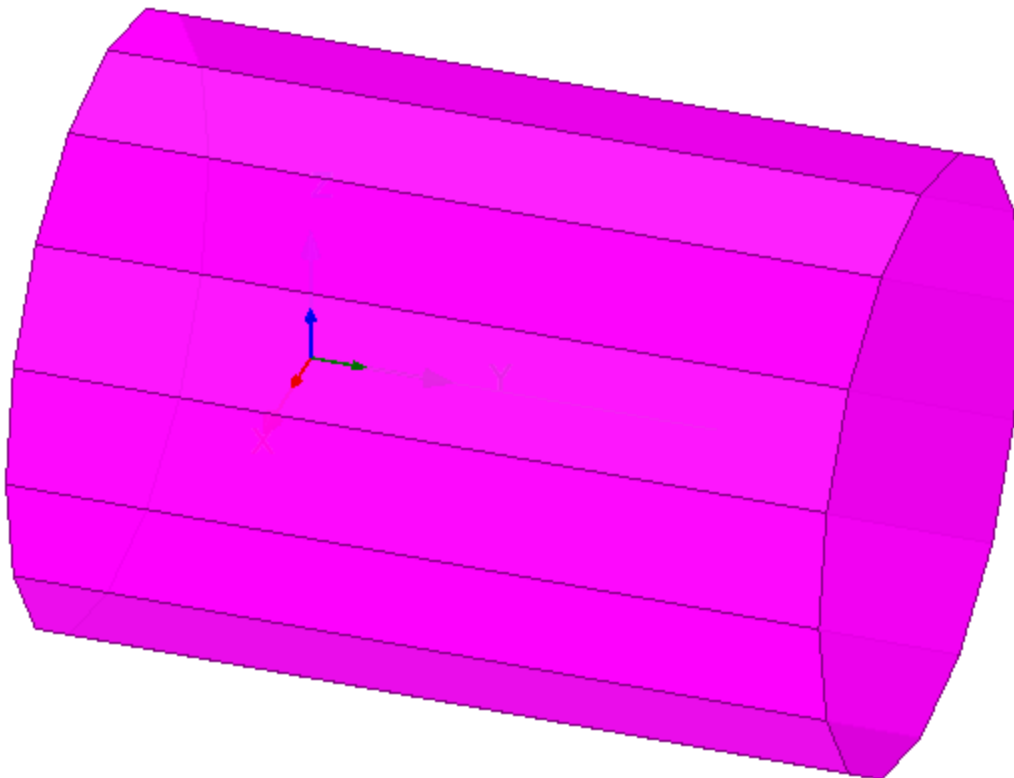

5. In the Project Manager, right-click **Boundaries** and choose **Assign > Radiation** from the context menu. Then:

- a. Click **OK** to accept the default *Name (Rad1)* and apply the boundary.



Rad1 appears under *Boundaries* in the Project Manager.

Note:

Assigning a radiation boundary to an object is equivalent to assigning it to every face of the object.

Hide *Cylinder_OR*

We will not have to interact with the segmented cylinder again and can therefore hide it:

6. Reselect the segmented cylinder object (*Cylinder_OR*).
7. On the **Draw** ribbon tab, click  **Hide selected objects in active view**.
8. On the **Draw** ribbon tab, click  **Fit All**.
9.  **Save** the model.

It's a good idea to save the project frequently as your work progresses.

Create Cable 3D Component

For this exercise you will define a cable using default conductor and insulation parameters. It will contain a single twisted pair, and the jacket will not be shielded. Create the cable component as follows:

1. In the Project Manager, right-click **3D Components** and choose **Cables > Edit Cables**.

The *Cable Editor* dialog box appears.

2. Click **Add > Straight Wire Cable**. Then:

- a. Click **OK** to accept the default straight wire properties shown in the following figure:

Properties: Cable_1TP - HFSSDesign1

Cable

	Name	Value	Unit	Evaluated Value	Description
	Name	stwire 1			
	Wire Standard	ISO			
	Wire Type	0.13			
	Conductor Diameter	0.55	mm	0.55mm	
	Conductor Material	"copper"		"copper"	
	Insulation Type	Thin Wall			
	Insulation Thickness	0.25	mm	0.25mm	
	Insulation Material	"PVC plastic"		"PVC plastic"	

3. In the **Cable Editor** dialog box, click **Add > Twisted Pair Cable**. Then, in the *Properties* dialog box that appears, do the following:
- a. Change the **Turns per Meter Value** to **50**:

Cable

	Name	Value	Unit	Evaluated Value	Description
	Name	tpwire 1			
	Contained Cable	stwire 1			
	Specify Lay Length	<input type="checkbox"/>			
	Turns Per Meter	50		50	
	Lay Length	20	mm	20mm	

Notice that the *Lay Length* (that is, the distance for one full 360-degree twist) is updated automatically to 20 mm.

- b. Click **OK** to accept these properties and add the twisted pair.
4. In the **Cable Editor** dialog box, click **Add > Bundle**. Then:

- a. Click **OK** to accept the default bundle properties shown in the following figure:

Cable		Shielding			
Name	Value	Unit	Evaluated Value	Description	
Name	bundle1				
Jacket Properties					
AutoPack	<input checked="" type="checkbox"/>				
Jacket Type	Insulation				
Jacket Material	"PVC plastic"		"PVC plastic"		
Jacket Inner Diameter	2.5	mm	2.5mm		
Insulation Thickness	0.25	mm	0.25mm		

5. In the tree at the left side of the *Cable Editor* dialog box, click and drag **tpwire1** onto **bundle1**. Then:
- a. Click **OK** to accept the default settings, shown in the following image, to add a single incidence of the twisted pair to the bundle:

Add Cable To Bundle ✕

Cable to add: tpwire1 ▼

Number of instances: 1

Instance base name: tpwire1

6. In the cable tree, expand the **tpwire1** and **bundle1** branches.

The Cable Editor dialog box should look like the following image:

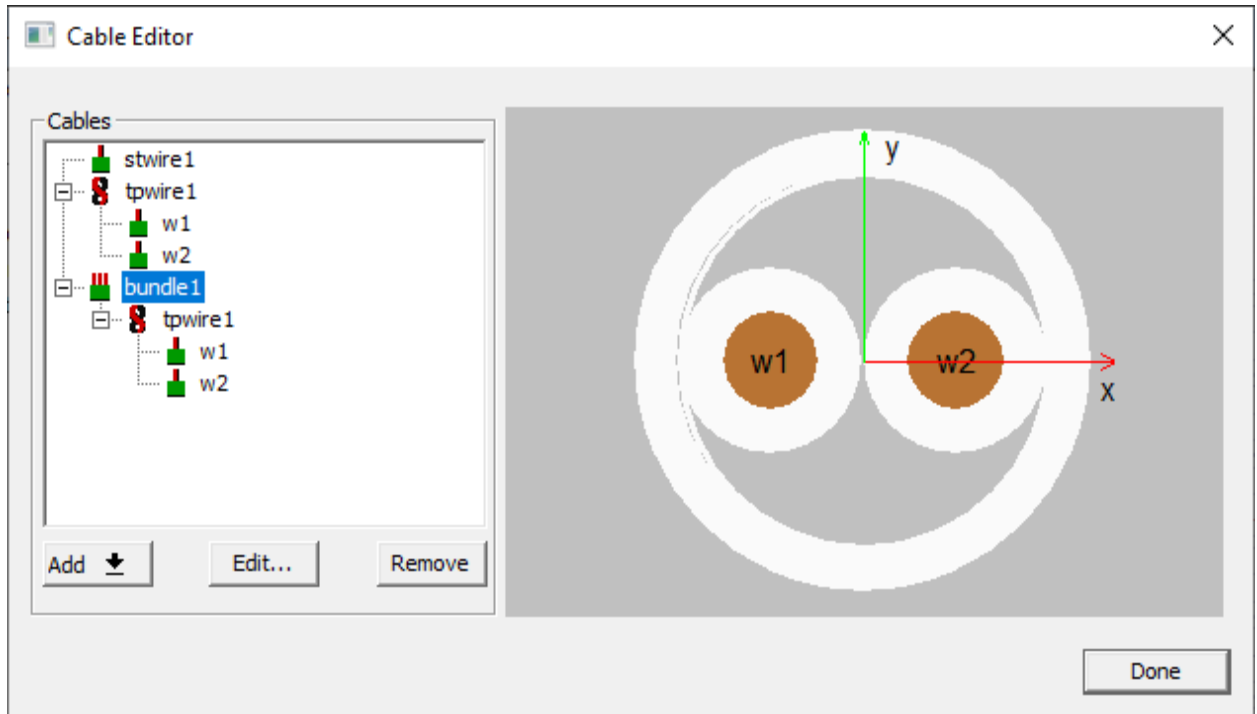

7. Click **Done** to complete the definition of the cable cross-section.

Create Cable Harness

To complete the cable definition, you will assign the cable to the previously drawn line, creating the cable harness. You will also define the reference conductor and the termination source and impedances.

1. In **Object** selection mode, click the previously drawn line (**Polyline1**) to select it.
2. In the Project Manager, right-click **3D Components** and choose **Cables > New Cable Harness**.

The *Insert Cable Harness Component* dialog box appears.

3. Under the *Definition* tab, type **my_harness** for the **Name**.

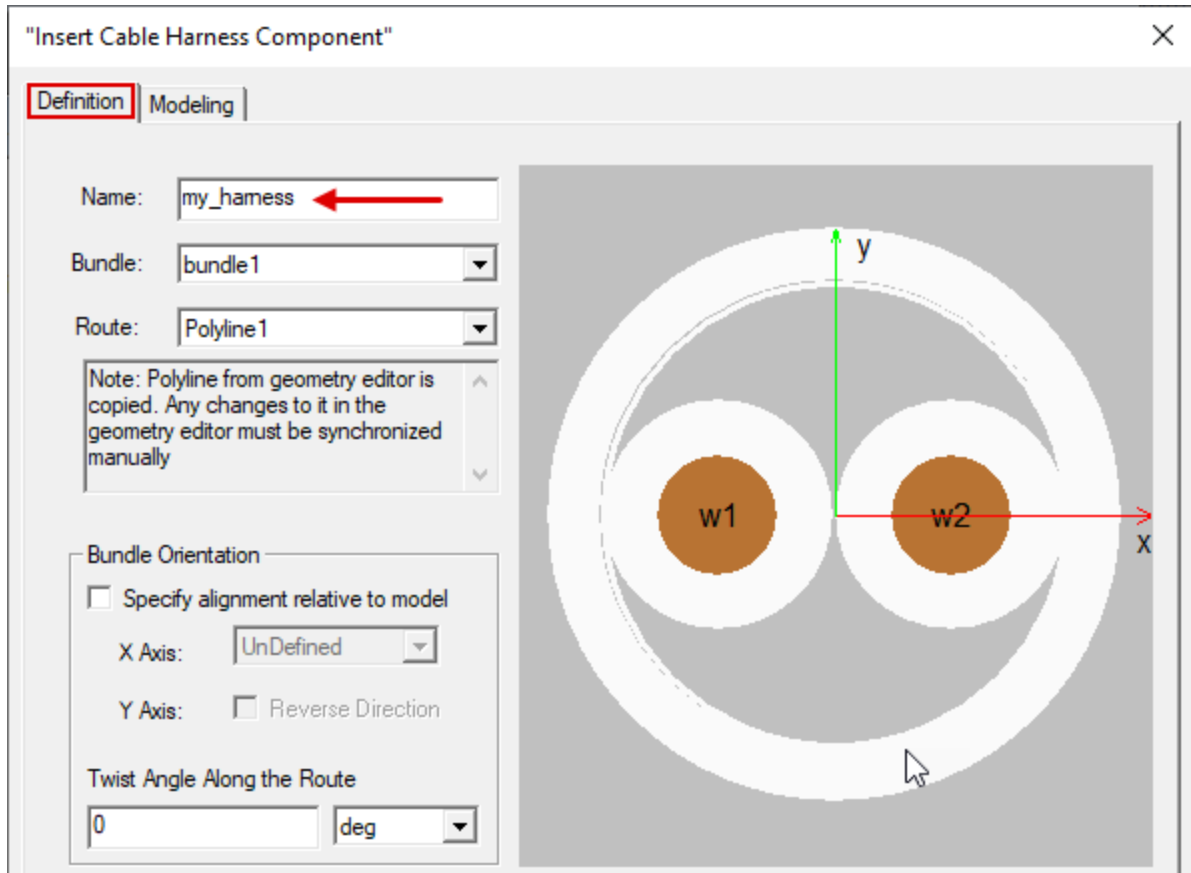

4. Select the **Modeling** tab of the *Insert Cable Harness Component* dialog box. Then:
 - a. Right-click **w2** (in the *Cable Terminations* tree at the left side of the dialog box) and choose **Reference Conductor** from the shortcut menu.

Note:

You can also execute this command from the cross-section view but, in that case, you must first click the conductor to select it and then right-click to access the shortcut menu.

- b. Right-click **w1** and choose **Input Termination > Source**. Then, in the *Set Source Termination* dialog box that appears, do the following:
 - i. Verify that the **Source Voltage**, is specified as **Single Source** and **5 V**.
 - ii. For **Impedance**, specify **0.1 ohm**.

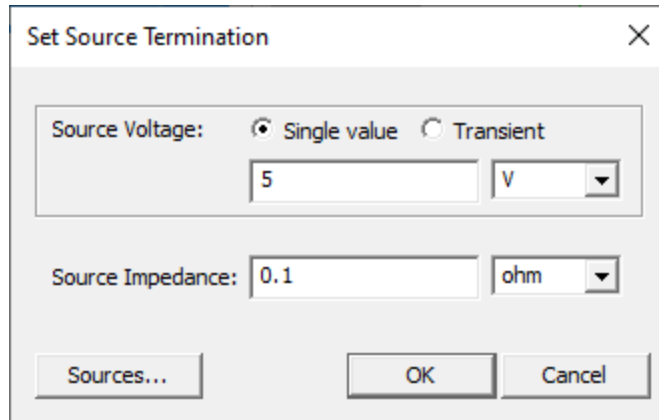

- iii. Click **OK**.
- c. Right-click **w1** again and choose **Output Termination > Impedance**. Then, in the *Set Impedance Termination* dialog box that appears, do the following:
 - i. Specify **110 ohm** for the **Impedance**:

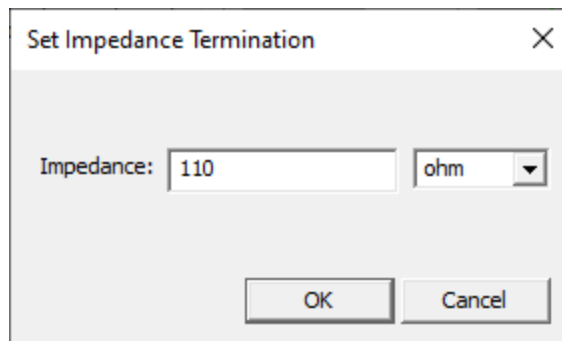

- ii. Click **OK**.

The *Modeling* tab of the *Insert Cable Harness Component* dialog box should match the following image:

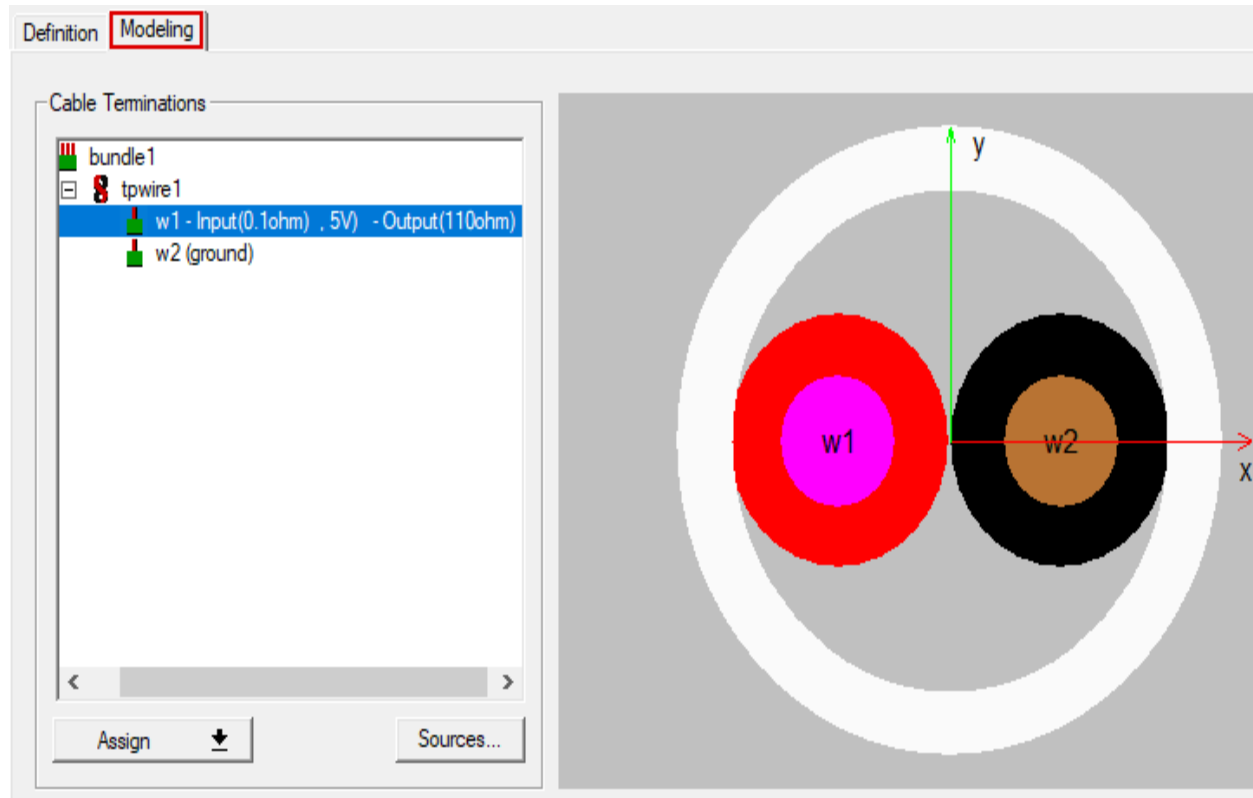

5. Click **OK** to complete the harness.
6. Click in the Modeler window background to clear the selection.

A small, red cylinder represents the cable harness. The cylinder's axis corresponds to Polyline1, and the cylinder diameter is automatically determined from the specified cable cross-section details:

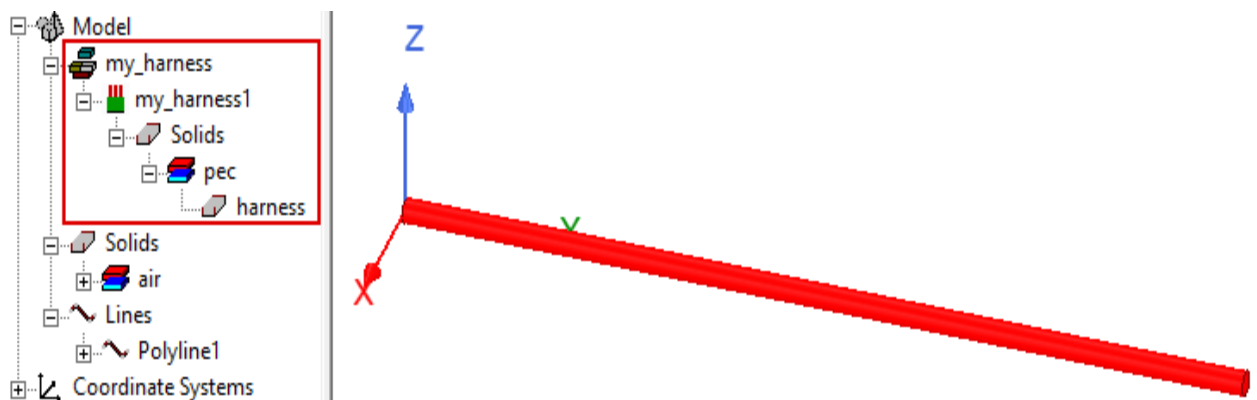

Note:

The harness is listed in the History Tree under the material "*pec*" (perfect electrical conductor). This designation is only used to have the *Solve Inside* option **cleared** within HFSS for the object's volume. The cable's 3D component definitions control the actual conductor and insulator materials, geometry, and other cable parameters. These definitions are the basis of 2D Extractor and Circuit simulations that occur in the background when the HFSS analyses is performed.

Additionally, the excitation, **my_harness1_cablenetwork1** has been created automatically, and it is listed in the Project Manager:

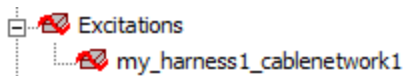

Draw Second Air Object

Create a cylinder that closely encloses the cable. After solving the model, you will overlay the E-field results on the curved face of this cylinder. The cylinder length will match the cable length of 100 mm, and the radius will be 4 mm. The distance between the cable jacket and the cylindrical face will be 2.7 mm, so you will be seeing near field results at close proximity to the cable.

The *dialog* input mode used to draw the first air object should still be in effect. Draw the air object as follows:

1. On the **Draw** ribbon tab, click  **Cylinder**. Then:
 - a. Specify the following settings under the **Command** tab of the *CreateCylinder* dialog box:
 - *Center Position*: **0, 0, 0**
 - *Axis*: **Y**
 - *Radius*: **4**
 - *Length*: **100**
 - *Number of Segments*: **0**

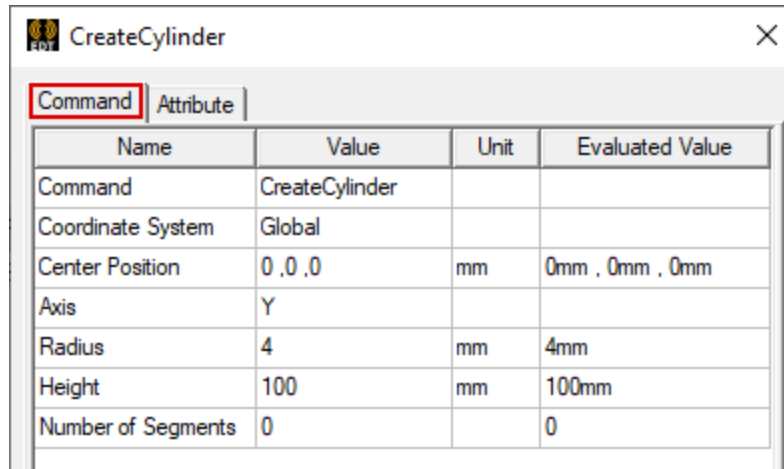

- b. Specify the following settings under the **Attribute** tab of the *CreateCylinder* dialog box:
- *Name*: **Cylinder_Near**
 - *Material*: **air**
 - *Transparent*: **0.2**

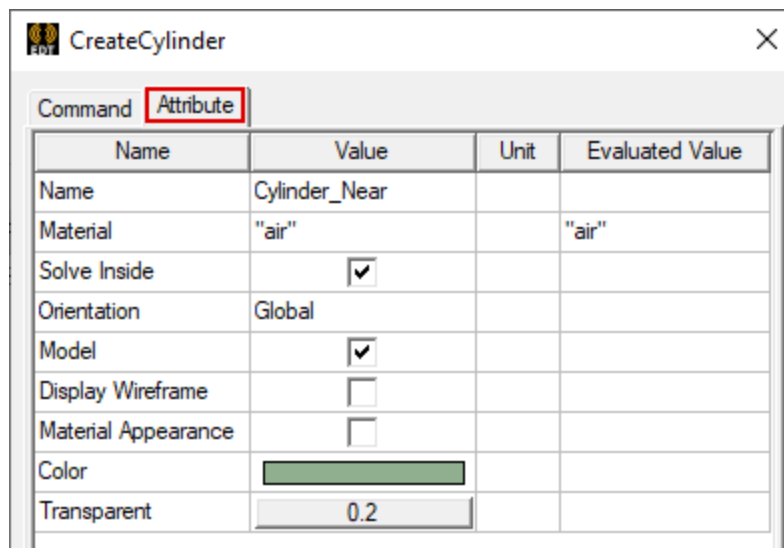

- c. Click **OK** to complete the cylinder.
2. On the **Draw** ribbon tab, click  **Fit All** and click in the *Modeler* window background to clear any selection.

The model should look like the following image:

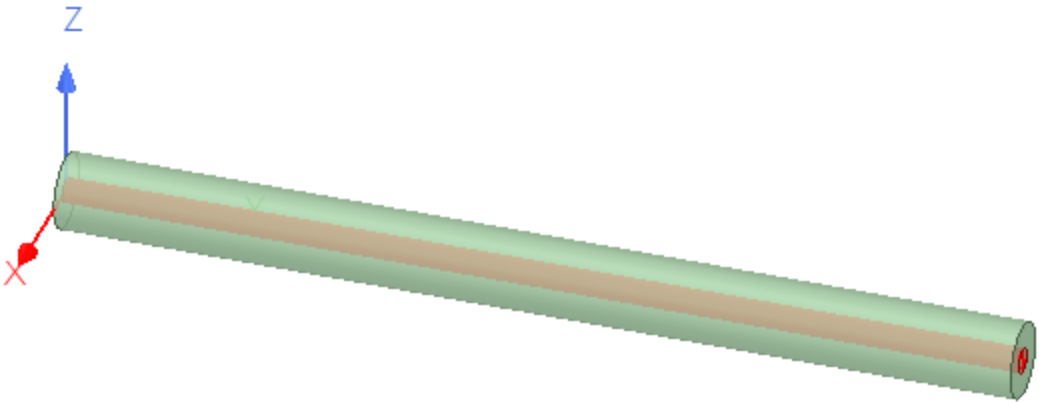

4 - Set Up Analysis and Solve

In this section you will complete the following steps:

- Adjust the initial mesh settings
- Assign a mesh operation to the smaller air object
- Add a solution setup and a frequency sweep
- Solve the design

Adjust Initial Mesh Settings

For smoother near field results we will specify higher than default mesh quality using the mesh slider in the *Initial Mesh Settings* dialog box, as follows:

1. Access the *Initial Mesh Settings* dialog box using one of the following two methods:
 - Right-click **Mesh** in the Project Manager and choose **Initial Mesh Settings** from the shortcut menu.
 - Using the menu bar, click **HFSS > Mesh > Initial Mesh Settings**.
2. In the *Curved Surface Meshing* section of the dialog box, click and drag the pointer two ticks to the right (towards Fine, to position 7):

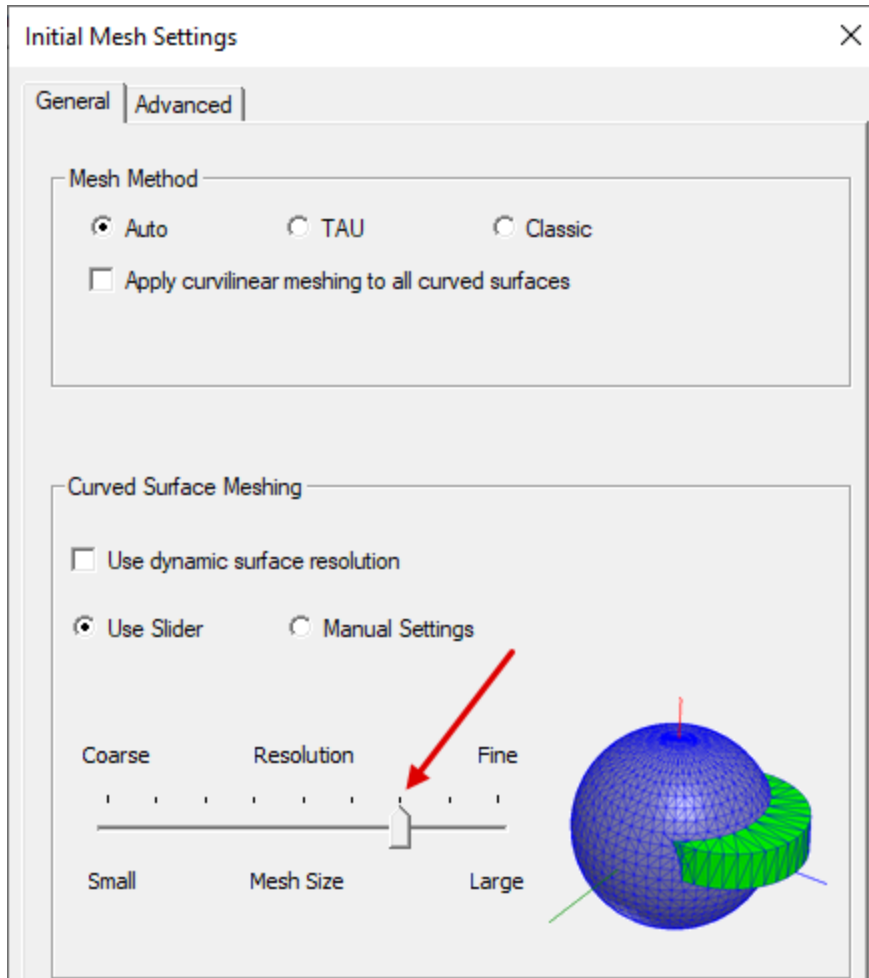

3. Click **OK**.

In the next topic, you will further refine the mesh by assigning a local mesh operation.

Assign Mesh Operation

For smooth field results in close proximity to the cable, assign a length-based mesh operation inside the smaller cylindrical air object (*Cylinder_Near*). This cylinder is hollow because the cable harness is implicitly subtracted from it. With an air object radius of 4 mm and a cable harness radius of 1.3 mm, the resulting wall thickness is 2.7 mm. By limiting the element length to 1.25 mm maximum (slightly less than half the wall thickness), at least three layers of elements will be generated across the wall thickness, preventing a single layer of long, thin tetrahedral elements. Additionally, the three layers of elements will provide a better transition of element size between the very fine mesh at the cable harness contact face and the relatively coarser mesh at the outside face. Assign the mesh refinement as follows:

1. In **Object** selection mode, click the **Cylinder_Near** air object:



2. Right-click **Mesh** in the Project Manager and choose **Assign Mesh Operation > Inside Selection > Length Based**.
3. In the *Element Length Based Refinement* dialog box that appears, specify **1.25 mm** as the **Set maximum element length** value and unit:

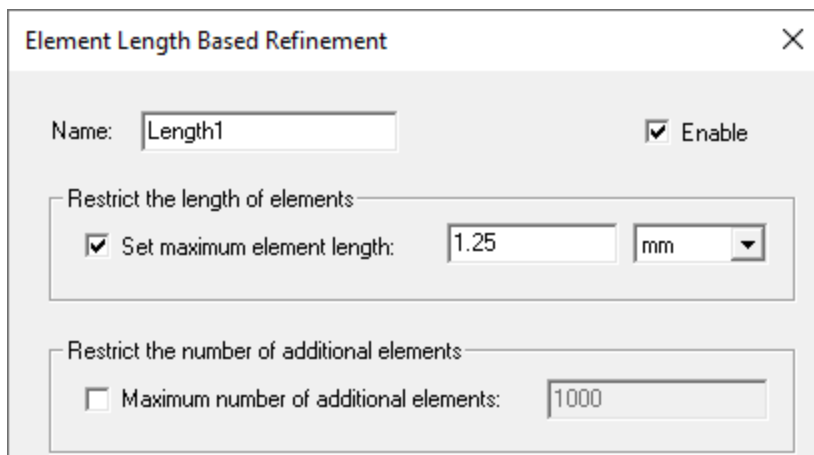

4. Click **OK**.

Add Solution Setup

Add an advanced solution setup specifying an adaptive solution frequency of 1 GHz, as follows

1. In the Project Manager, right-click **Analysis** and choose **Add Solution Setup > Advanced**.

The *Driven Solution Setup* dialog box that appears:

2. Specify **1 GHz** for the **Frequency** of the adaptive solution.

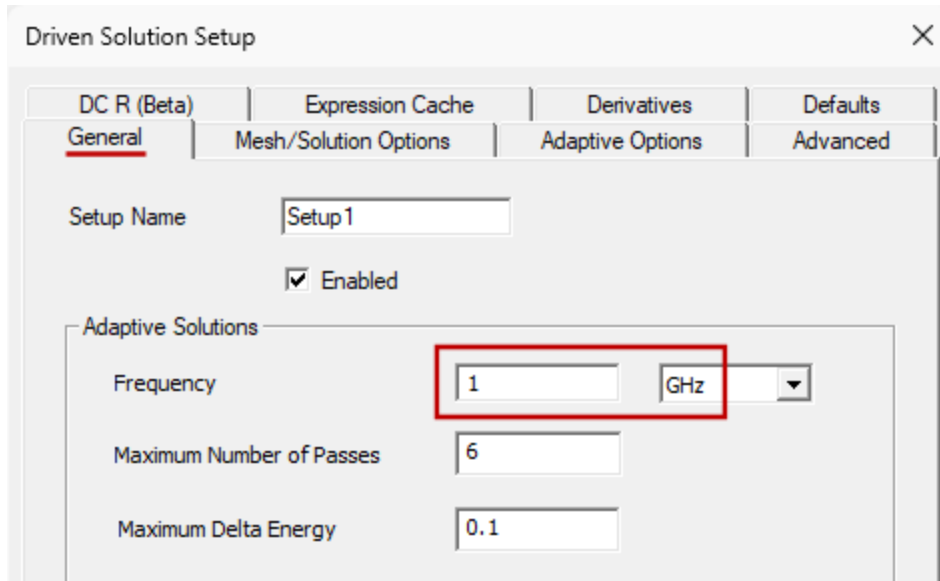

3. Click **OK**.

Add Frequency Sweep and Solve

Add a frequency sweep spanning from 0.1 to 2 GHz in 0.1 GHz increments. Then run the analysis.

1. Under *Analysis* in the Project Manager, right-click **Setup1** and choose **Add Frequency Sweep**.
2. In the *Edit Frequency Sweep* dialog box that appears, specify the following settings:
 - *Sweep Type*: **Discrete**
 - *Distribution*: **Linear Step**
 - *Start*: **0.1GHz**
 - *End*: **2GHz**
 - *Step Size*: **0.1GHz**
 - *Save Fields (All Frequencies)*: **selected**

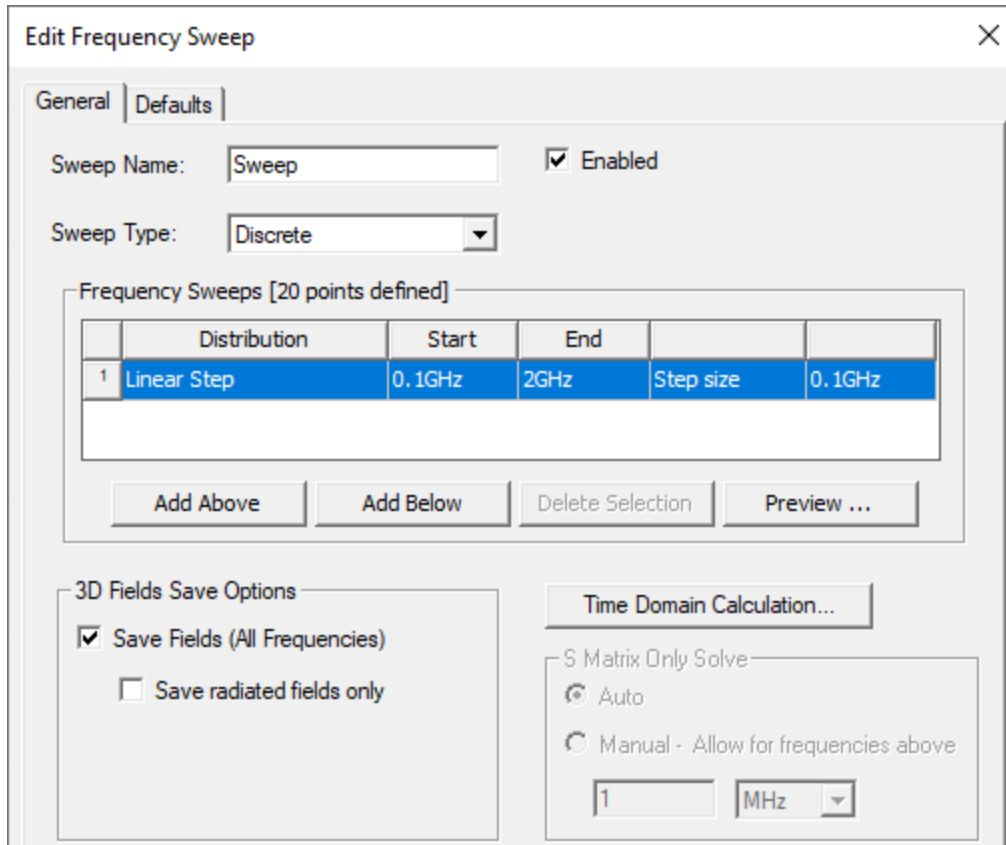

3. Click **OK**.

Sweep appears under *Analysis > Setup1* in the Project Manager.

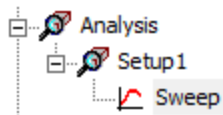

4.  **Save** your project.
5. Begin solving the analysis using one of the following three methods:

- On the **Simulation** ribbon tab, click  **Analyze All**.
- From the menu bar, click **HFSS > Analyze All**.
- Right-click **Analysis** in the Project Manager and choose **Analyze All**.

Note:

Because of the relatively fine mesh, the number of frequencies in the sweep, and background 2D Extractor and Q3D simulations that must be run, this solution may take up to about 30 minutes to solve. Newer, high-end workstations with over eight cores should take less time than that.

5 - Evaluate Results

In this section you will complete the following steps:

- Overlay a mesh plot on Cylinder_Near
- Create an emission test report
- Create a polar plot of the radiation pattern
- Overlay and animate the electric field

Overlay Mesh Plot

Examine the mesh in the most highly refined portion of the model, Cylinder_Near, as follows:

1. Select **Cylinder_Near**.



2. In the Project Manager, right-click **Field Overlays** and choose **Plot Mesh** from the shortcut menu.

The *Create Mesh Plot* dialog box appears:

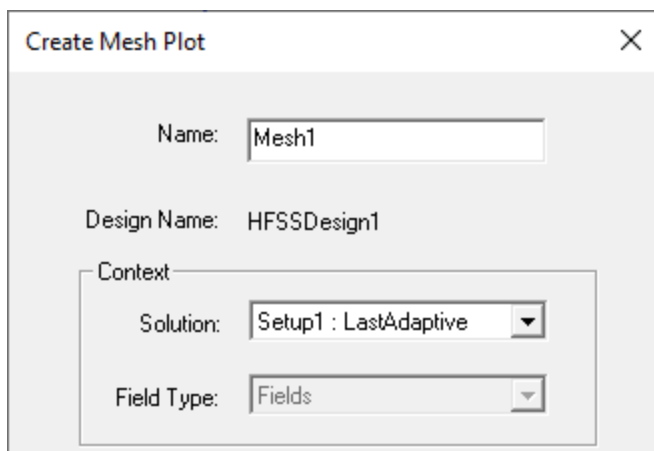

3. Click **Done** to accept the default settings and create the mesh plot.

4. Rotate and zoom the model viewpoint for a closer look at the mesh on the right end of the cylinder. The display should resemble the following image:

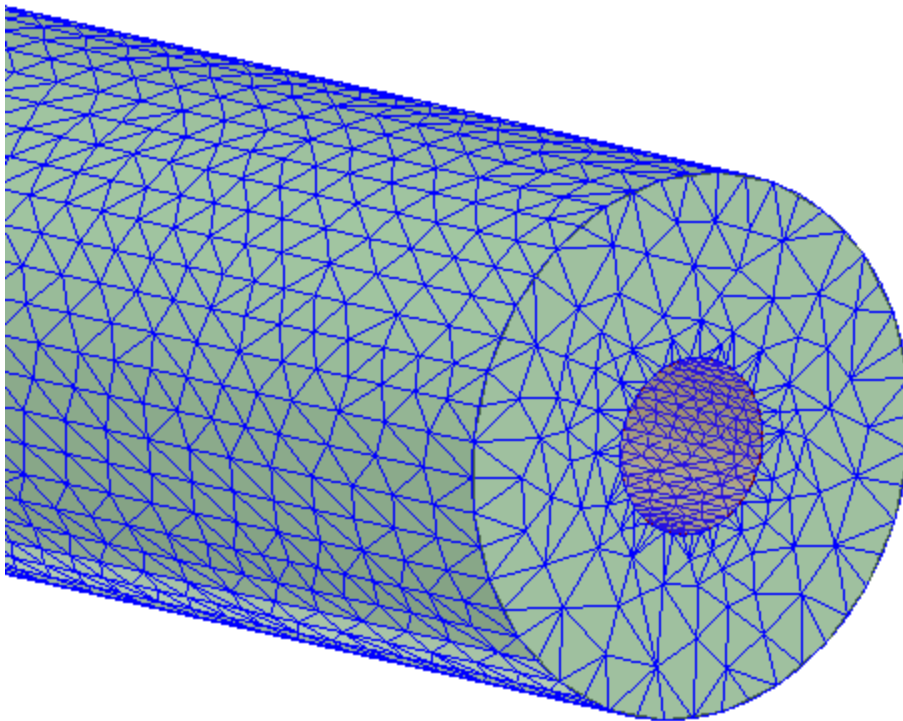

Observations:

There are predominantly four layers of elements between the inner and outer cylindrical faces. The sizing of the elements is consistent, and the aspect ratios appear to be reasonably good to the extent that is apparent from the surface mesh. This mesh should produce high-quality field results.

5. Under *Field Overlays > Mesh Plots* in the Project Manager, Right-click **Mesh1** and clear the **Plot Visibility** option in the shortcut menu.

The mesh overlay will now only be visible only when selected in the Project Manager, which will keep other overlays you will create cleaner.

Create Emission Test Report

Create a report showing the E-Field emission (in dBm) at a distance of 10 meters across the frequency sweep. The sweep covers a range of 100 MHz to 2 GHz. The wavelength (λ) at 100 MHz is 3 meters. Far fields are considered to be those at a distance of 2λ or more (≥ 6 m). By choosing a 10 m cylindrical emission report, results for the entire sweep qualify as far field results. Create the report as follows:

1. Access the *Report* dialog box using one of the following three methods:

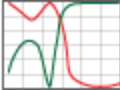
- On the **Results** ribbon tab, click  **Emission Test Report** >  **2D**.
- Right-click **Results** in the Project Manager and choose **Create Emission Test Report** > **Rectangular Plot** from the shortcut menu.
- From the menu bar, click **HFSS** > **Results** > **Create Emission Test Report** > **Rectangular Plot**.

2. Specify the following general and *Trace* tab settings:

- *Solution*: **Setup1 : Sweep**
- *Category*: **Cylinder**
- *Quantity*: **Cylinder 10meters**
- *Function*: **dBm**

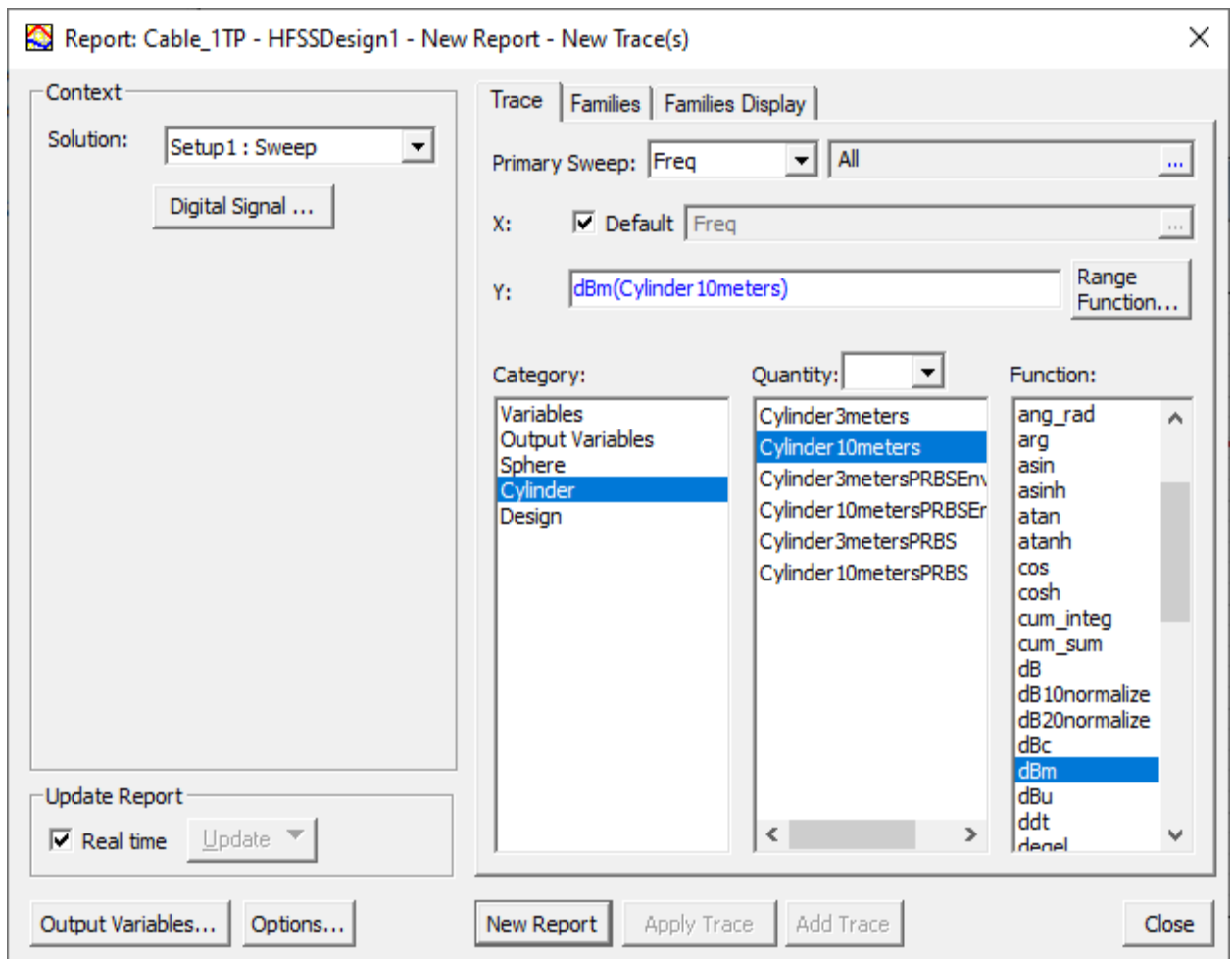

3. Click **New Report** to create the report and click **Close**.
4. Right-click in the *Cylinder Plot 1* window and choose **Marker** > **Add Marker**.

5. Click on the curve exactly where it intersects the 1 GHz vertical grid line.
6. Press **Esc** to end the add marker mode.
7. Drag the plot legend and marker table to position them as desired.

Your 2D plot should resemble the following image:

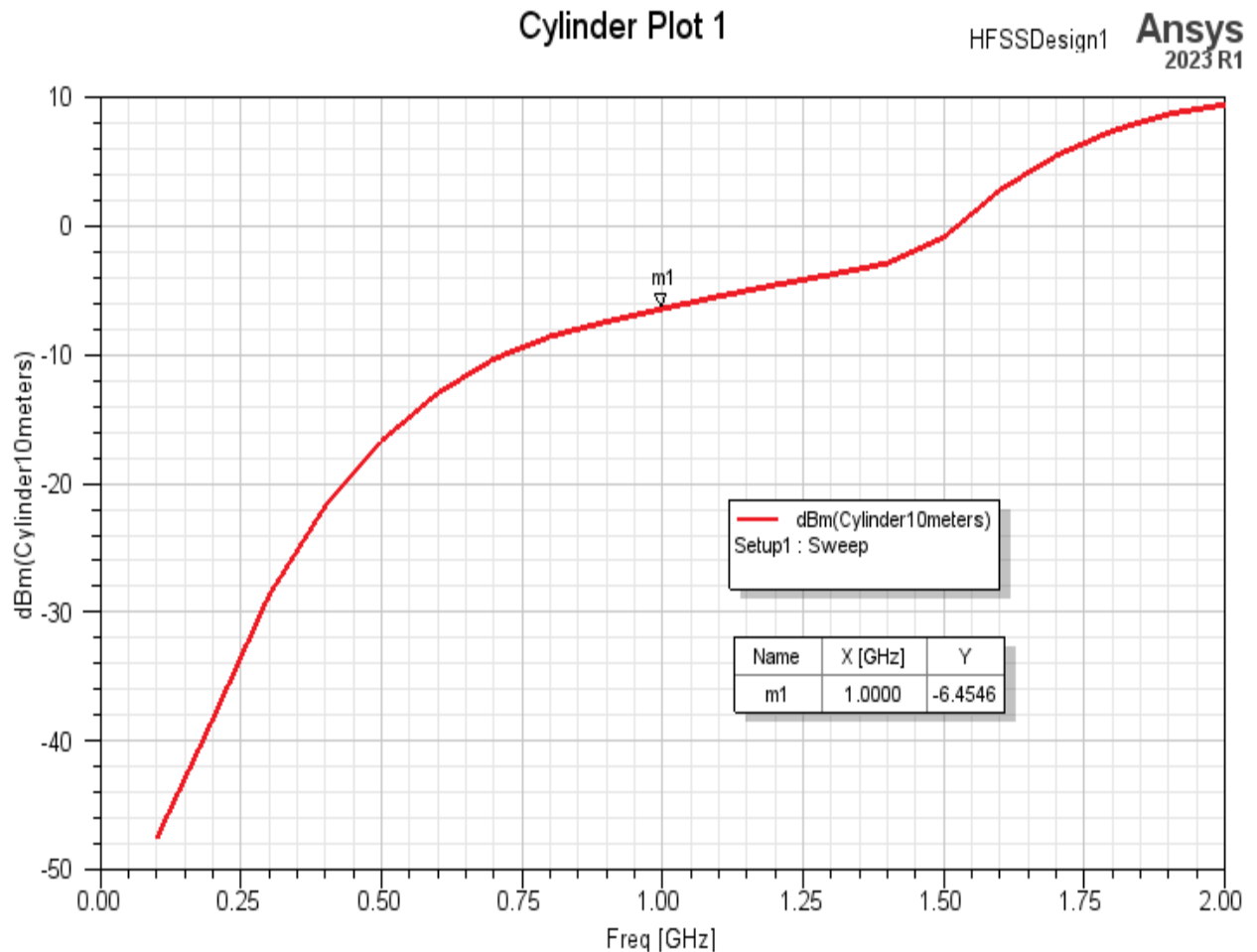

Observations:

- Throughout the swept range, the E-Field strength increases with frequency.
- The rate of increase in dBm emission level with frequency is not constant. Over the swept range, you can see two bands of rapid increase and two bands of more gradual increase. Of course, dBm is a logarithmic measurement, so even a constant non-zero slope does not represent linear behavior.
- At the adaptive solution frequency of 1 GHz, the E-Field strength is approximately -6.5 dBm.

Plot Radiation Pattern

Before making a polar plot of the radiation pattern, you must define a far-field setup. Create an infinite sphere far-field setup and create a polar plot of the radiated electric field (in dBm) as follows:

1. Right-click **Radiation** in the Project Manager and choose **Insert Far Field Setup > Infinite Sphere**. Then:
 - a. Specify the following settings in the *Far Field Radiation Sphere Setup* dialog box that appears:

Phi:

- *Start: 0 deg*
- *Stop: 0 deg*

Theta:

- *Start: 0 deg*
- *Stop: 360 deg*
- *Step: 5 deg*

Far Field Radiation Sphere Setup

Infinite Sphere | Coordinate System | Radiation Surface

Name: Infinite Sphere1

Phi

Start: 0 deg

Stop: 0 deg

Step Size: 2 deg

Theta

Start: 0 deg

Stop: 360 deg

Step Size: 5 deg

b. Click **OK**.

Infinite Sphere1 appears under *Radiation* in the Project Manager.

2. On the **Results** ribbon tab, click  **Far Fields Report** >  **Mag/Ang Polar**.
Then:

a. Specify the following settings in the *Report* dialog box that appears:

Context section:

- *Solution*: **Setup1 : Sweep**
- *Geometry*: **Infinite Sphere1**

Trace tab:

- *Primary Sweep*: **Theta**
- *Category*: **rE**
- *Quantity*: **rETotal**
- *Function*: **dBm**

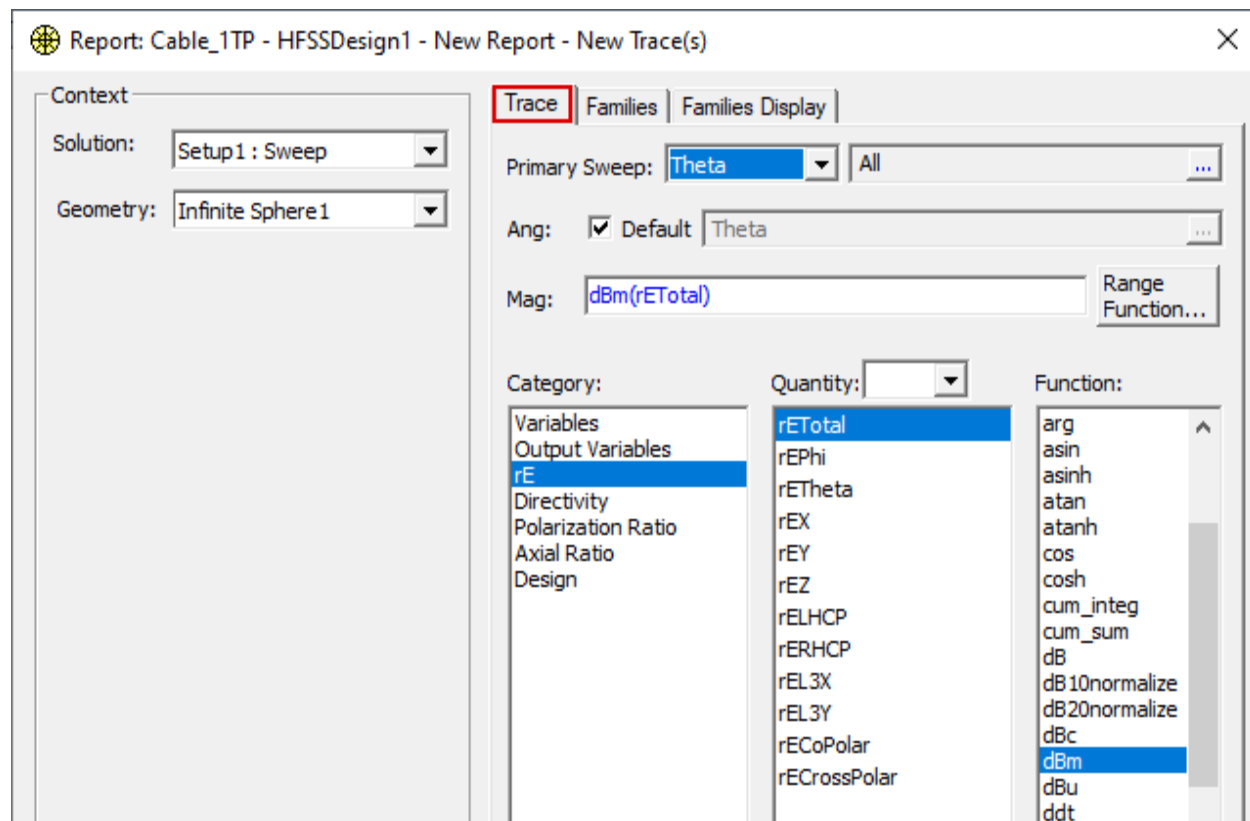

Families tab:

- **Phi: All**

Only one *Phi* value (0 deg) is available in the *Infinite Sphere1* definition.

- **Frequency: 0.1GHz, 0.2GHz, 0.4GHz, 0.6GHz, 0.8GHz, 1.0GHz, 1.2GHz, 1.4GHz, and 1.6GHz.**

Click the ellipsis button (...) to access the list of available frequencies. Ensure that **Select values** is selected and use **Ctrl+click** to selected multiple frequencies.

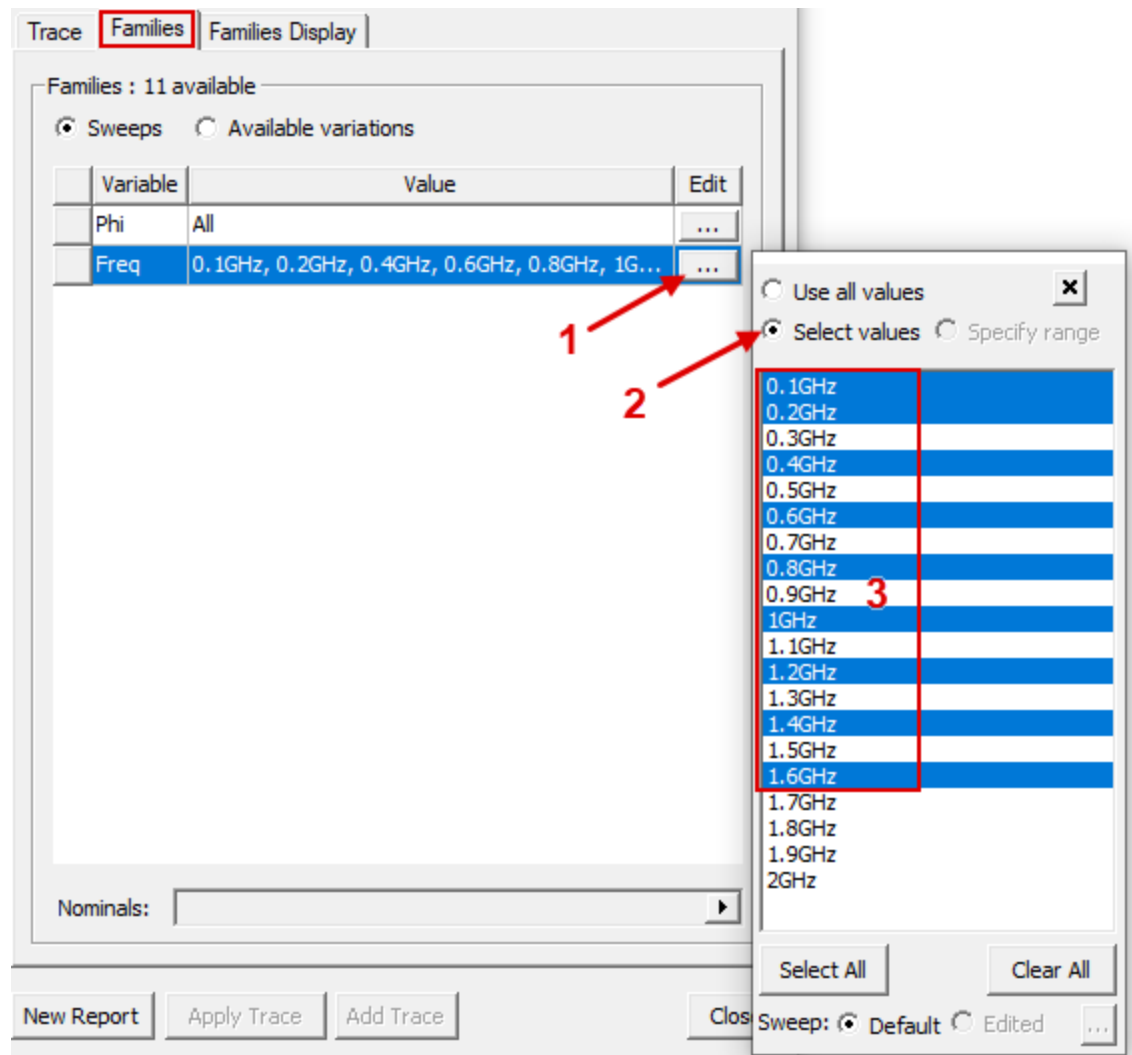

- Click **New Report** to create the plot.
 - Click **Close** to close the *Report* dialog box.
- Resize the plot legend and drag its location as desired.
 - Under *Results* in the Project Manager, right-click **rE Plot1** and choose **Rename**. Then:

- a. Type **Radiation Pattern**.
- b. Press **Enter**.

The plot should now resemble the following image:

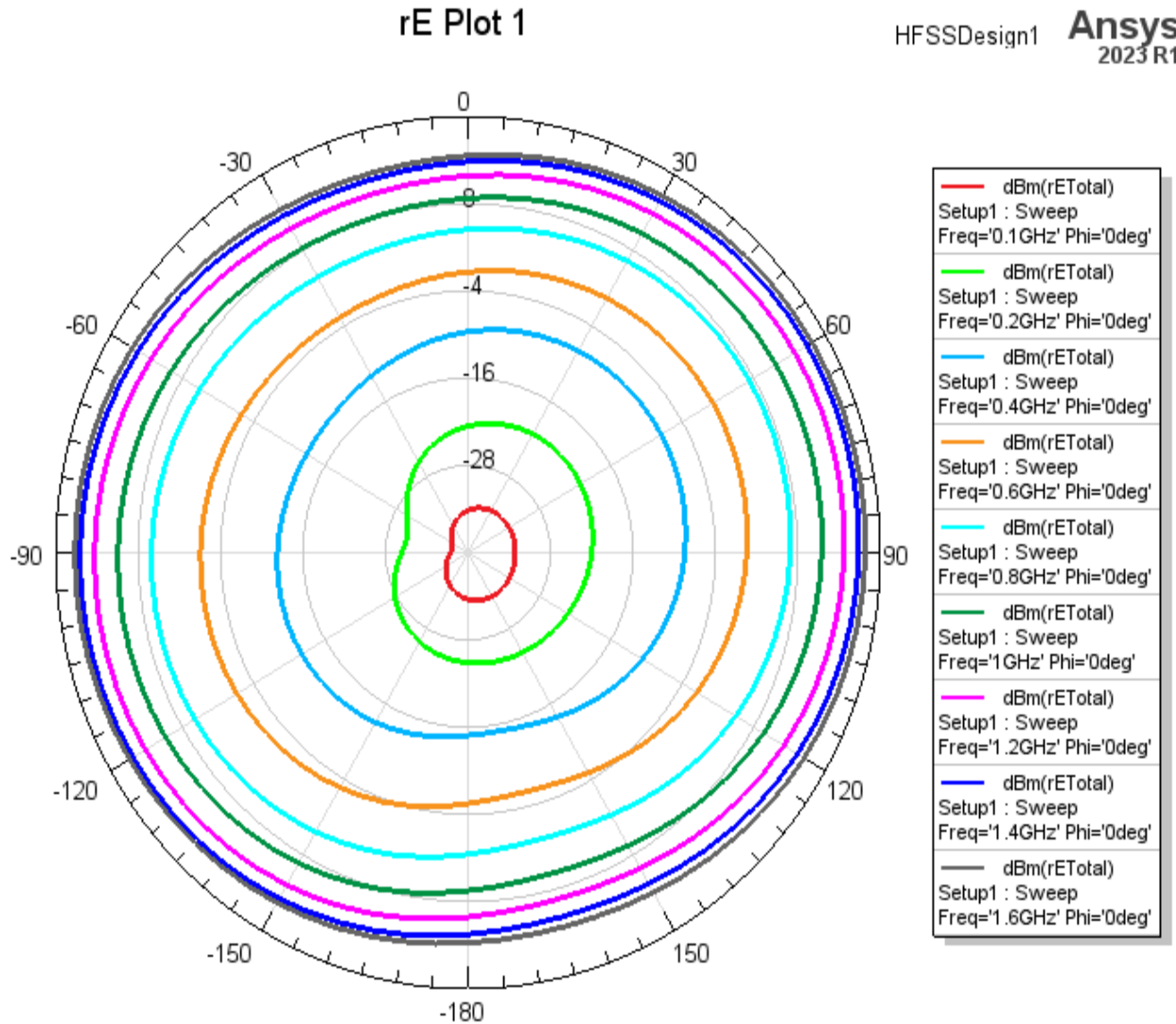

Overlay and Animate E-Field

Overlay the Mag_E field result on the outer cylindrical face of *Cylinder_Near* to see the E-field in close proximity to the cable. Choose a sweep frequency and phase angle as a basis of the overlay. Then, animate this overlay with respect to frequency. Create the overlay and animation as follows:

1. Click in the Modeler window background to ensure that this is the active window and press **F** to switch to the *Face* selection mode.
2. Click the **outer cylindrical face** of *Cylinder_Near* to select it:



3. In the Project Manager, right-click **Field Overlays** and choose **Plot Fields > E > Mag_E** from the shortcut menu. Then:
 - a. In the *Create Field Plot* dialog box that appears, specify the following settings:
 - *Solution*: **Setup1 : Sweep**
 - *Freq*: **100MHz**
 - *Phase*: **10deg**

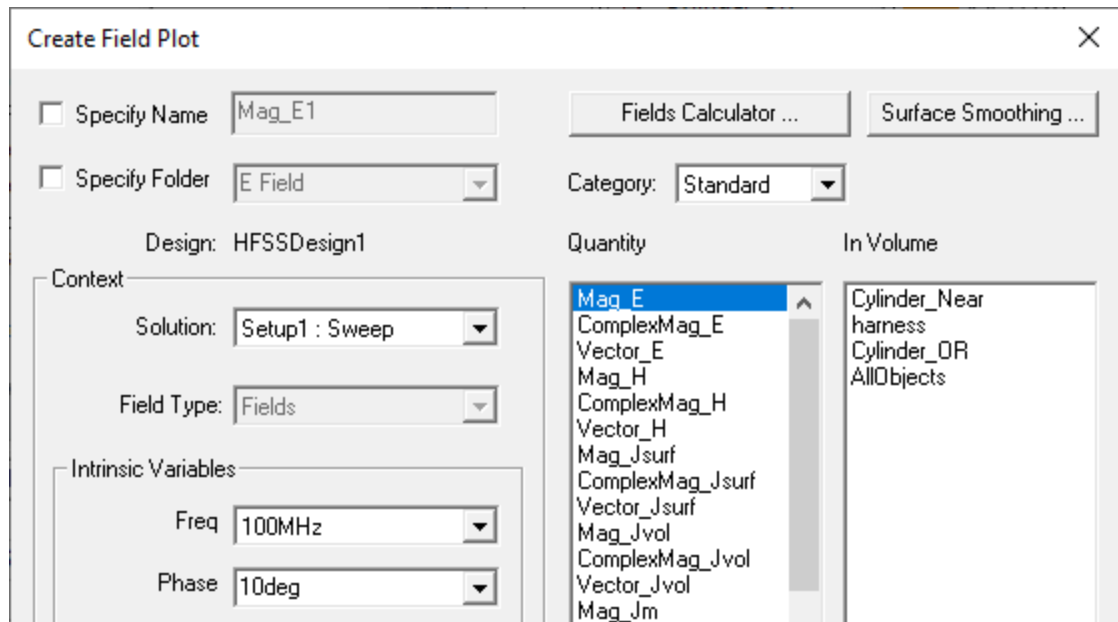

Note:

The lowest frequency in the sweep (100 MHz) provides an E-field pattern that most clearly reveals the twisted pair of conductors in the cable. At higher frequencies, there is a noticeable phase shift along the length of the cable, which modulates the field intensity. Additionally, the E-field pattern is the most uniform throughout the cable length at the 10-degree phase angle.

In the subsequent animation, you will see the field results at multiple frequencies and the increasing phase shift along the cable length at higher frequencies than 100 MHz.

- b. Click **Done** to create the overlay, which should resemble the following image:

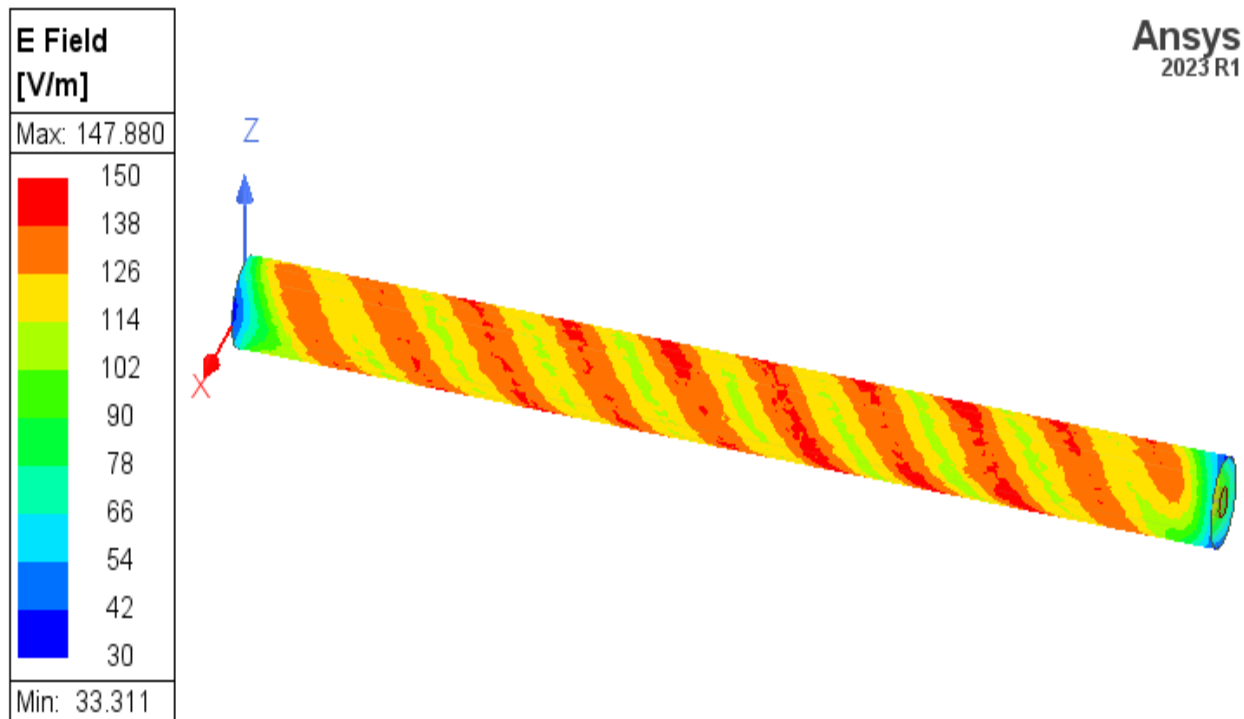

4. Under *Field Overlays* > *E Field* in the Project Manager, right-click **Mag_E1** and choose **Animate**. Then:
- a. In the *Create Animation Setup* dialog box that appears, specify the following settings:
 - *Swept Variable(s)*: **Single Variable** and **Freq**
 - *Select Values*: **All Frequencies**

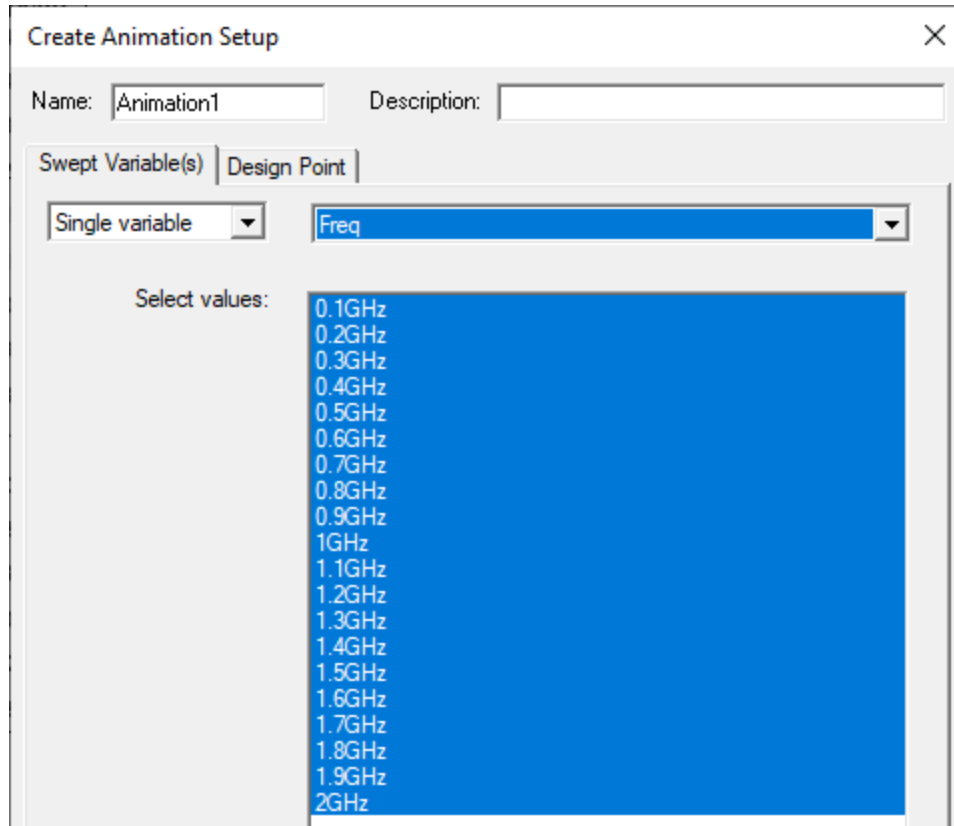

- b. Click **OK** to start the animation.

It will take a few seconds for the animation frames to be created. The animation should resemble the following:

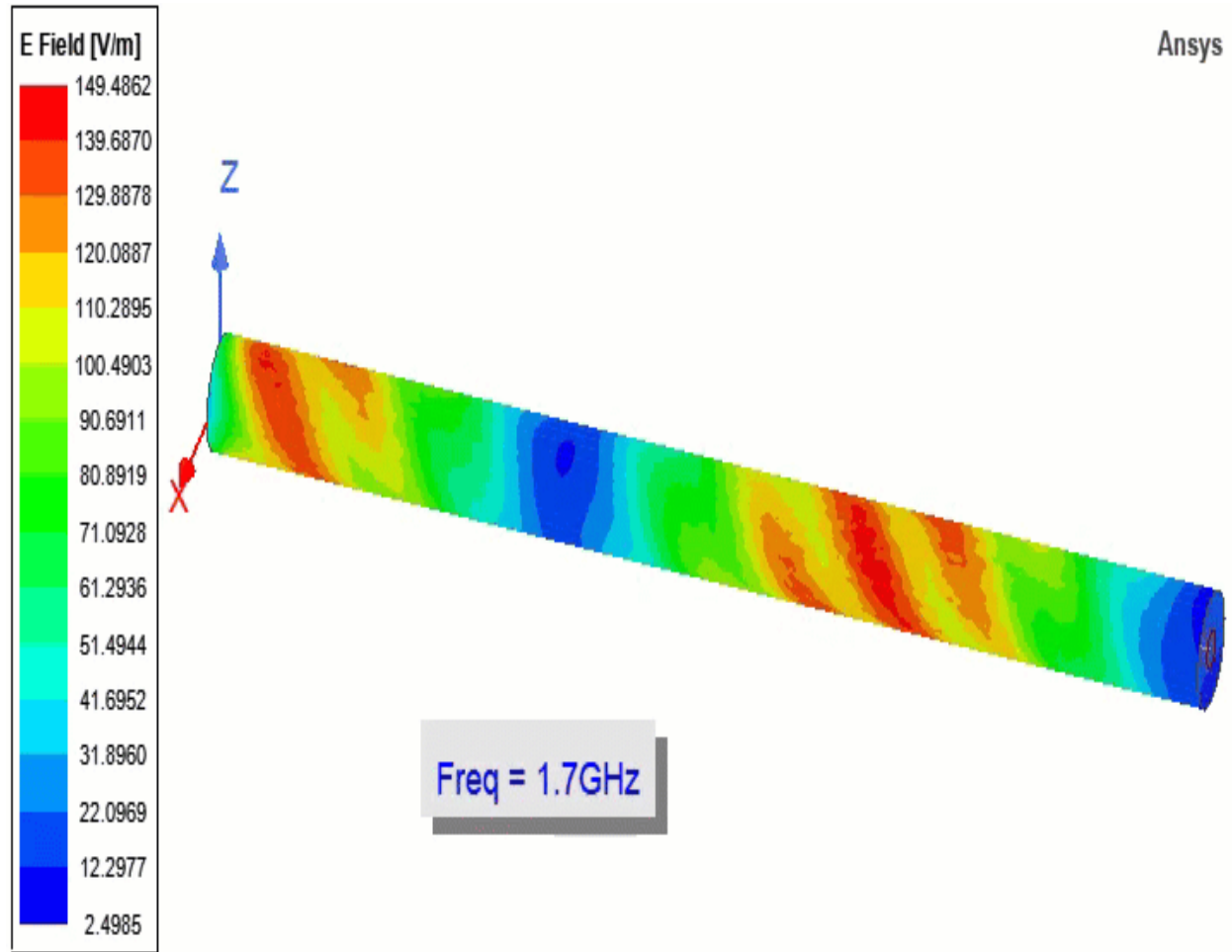

5. Use the controls in the *Animation* dialog box to stop, reverse, step frame-by-frame, or adjust the speed of the animation:

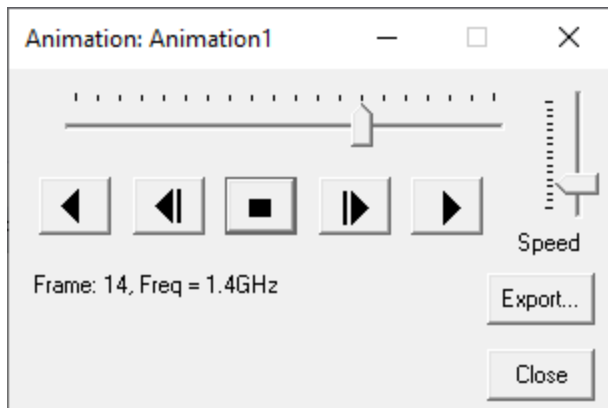

Observations:

Initial Static E-Field Overlay:

- At first glance, you might think you are looking at a single helix with a pitch of 10 mm. In reality, you are seeing a double helix (two intertwined helices) with a lead of 20 mm (one helix for each conductor in the twisted pair). Each helix is rotated 180° relative to the other one. The 20-mm lead corresponds to the specified 50 twists per meter of the twisted pair:

$$1000 \text{ mm} / 50 \text{ twists} = 20 \text{ mm/twist}$$

- Because of edge effects at the ends of the cable harness and cylinder on which the results are overlaid, the field intensity is somewhat diminished near the left and right ends of the overlay. So, the maximum field intensity doesn't extend for the full 100-mm cable length. As a result, you are able to clearly see about 4.5 turns in the red contour. If you project the path of the red contour to the left and right ends, you can infer five full turns of each helix, as expected:

$$100 \text{ mm} / 20 \text{ mm/twist} = 5 \text{ twists}$$

Frequency Animation:

- The plot legend range is adjusted to accommodate the minimum E-field strength that occurs at 90-degree and 270-degree phase shifts, which only occur at frequencies significantly above 100 MHz.
- A phase shift of 90° along the full length of the cable is observed at 0.6 GHz, 180° at 1.2 GHz, and 270° at about 1.7 GHz.

6. Press **Close** to terminate the animation when you are done observing it.

7.  **Save** your project.

6 - Optionally, Restore Current View Orientations

You have completed this getting started guide.

If you prefer to use the new view orientations implemented in version 2024 R1 of the Ansys Electronics Desktop application, clear the *Use Legacy View Orientation* option as follows:

1. From the menu bar, click **View > Options**.

The *3D UI Options* dialog box appears.

2. Ensure that **Enable Legacy View Orientation** is cleared:

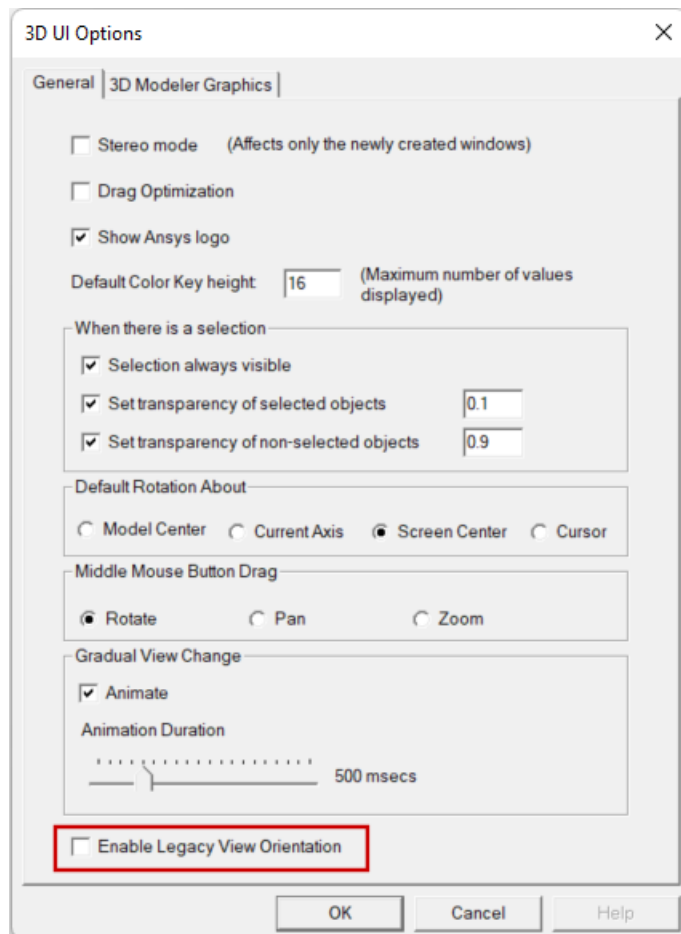

3. Click **OK**.

The settings in the 3D UI Options dialog box are global. Your choice is retained for all future program sessions, projects, and design types that use the 3D Modeler or that produce 3D plots of results.

You can now save and close this project.